

1. STEP (tools & care)

To assemble the building you will need the following tools:



Care

Tools and materials

Even though most of the wooden parts have been smoothly finished there is still a chance of splinters, so be careful when taking hold of the parts. Always wear gloves, eye protection and long sleeves while assembling the log cabin or when carrying out maintenance.

Always cut away from yourself when using a knife or chisel. Do not hold your fingers behind the wooden part that you are cutting or sawing.

Be careful with the tools that you use when assembling the log cabin. Make sure that you know how to handle any electrical tools used.

Do not proceed with the assembly of the cabin if components are missing, as weather damage may be caused if the cabin is left partly assembled.

Working on ladders and roofs

Care is required when working from a ladder or on a roof. Ensure that the ladder has a sound footing and rests against a solid object of adequate strength. Do not leave heavy or sharp objects in places where they may be dislodged.

Weather conditions

Avoid erecting the cabin in strong winds or heavy rain.

Children

Keep children away from the working area, and keep ladders, tools and cabin components out of their reach. Do not allow them to climb on the cabin.

2. STEP

Before erecting this building it is important to make a firm base, ideally using concrete or concrete slabs.

It is very important that the base corners must be at right angles it is completely level. Unless in the wall between windows and doors can be found space, in consequence water can get into the cabin.

It is very important!

Foundation ground must be leveled horizontally, and all four corners must be the stat of 90 degrees. **MUST** use a spirit level and measure the diagonal from corner to corner!

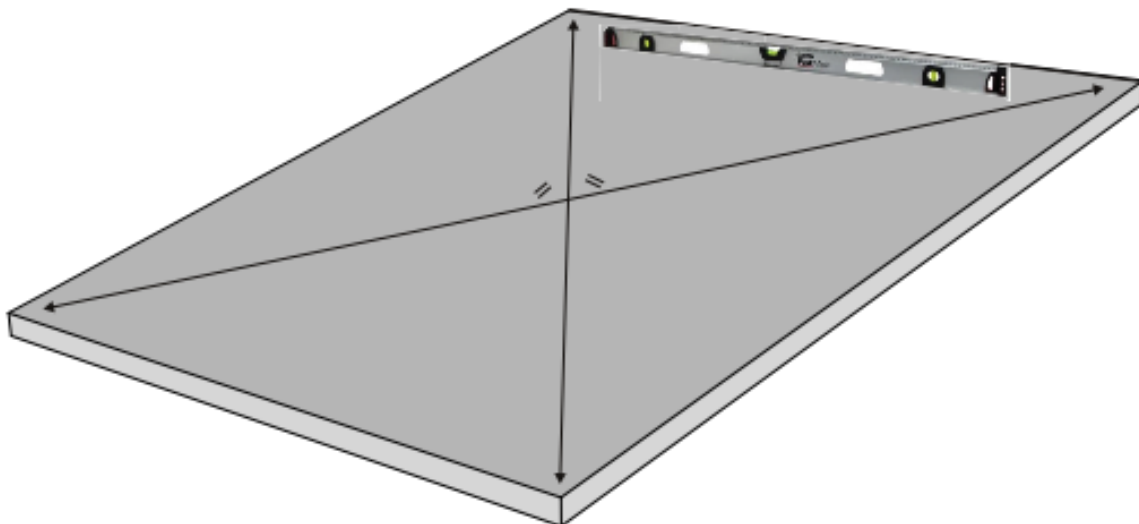
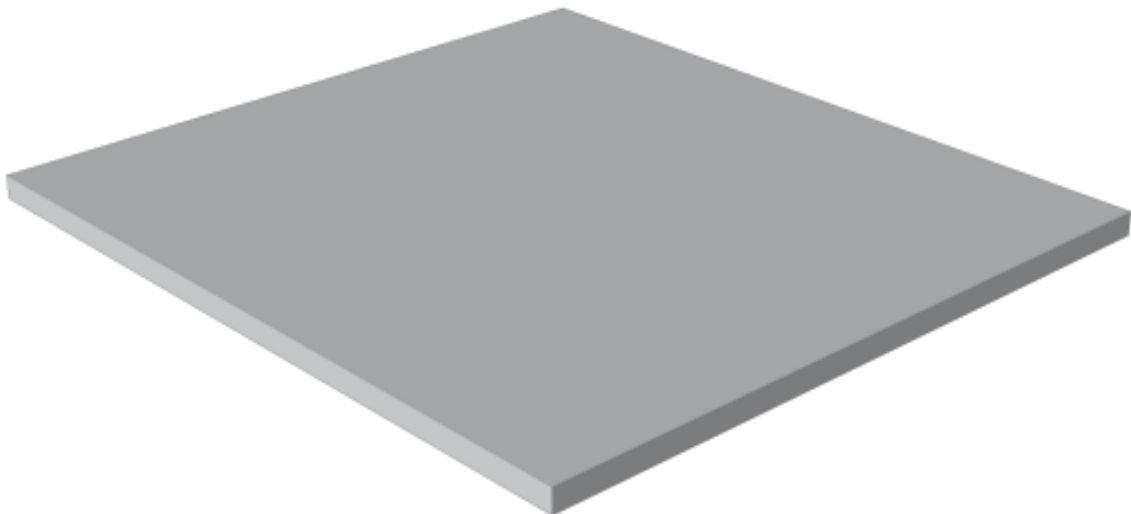

3. STEP

Assembling this building should take place during dry weather only. If it starts to rain during the assembling process, the wood should be covered over.

Opening the packing house and parts sorting by position, and house walls sorted by walls axis.



Wall barcode explanation

Position from the parts list

Detail dimension

Wall row number

Axis

With which axis intersect

Position: 017.

0000078826

Dimension: 44x135x545

Name: 12-1-A wall

ard/Sienoias

Detail barcode explanation

Position from the parts list

Detail dimension

Detail position

Details quantities numbering

Position: 037.

0000514242

Dimension: 20x130x1721

Name: 037-1 Roof

ard/ Stoga lentos

After completing the base the bearers, Pos. 003 are put into position following the Installation Guide diagrams, and then bolted into position.

The space between impregnated floor joists must be kept exactly how is shown at the Foundation plans.

The first two and the last two impregnated logs must be put together. According to the picture.

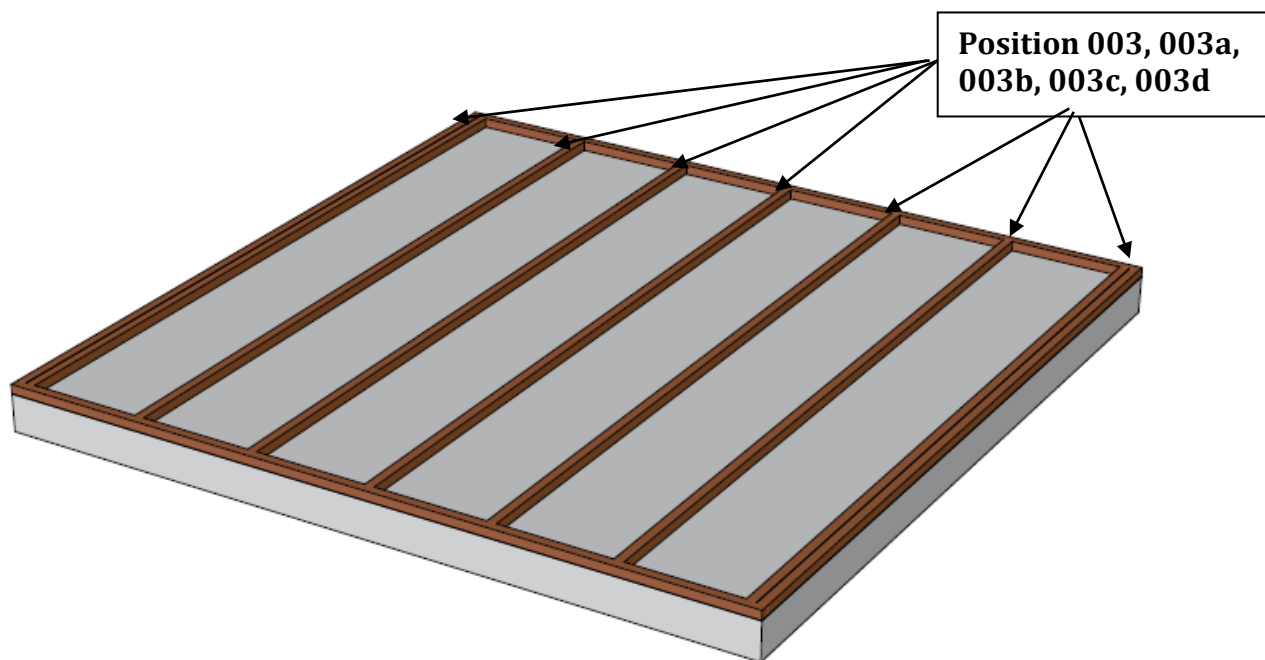

4. STEP

It is advisable to use a spirit level during the construction of the cabin. Using the Installation guide together with the Parts List for reference you can start erecting the walls.

Beginning with part for the back and front walls and following the installation Guide, fit the boards' one on top of the other. Ensuring the corners lock. Again it is advisable to use a spirit level during this process.

Screw Installation.

At equal distances, drill a pilot hole with a 5mm drill bit in to the timber boards as directed in the diagrams below. With the screw's supplied, place them in to the holes and secure tightly. The number of screws to use for certain wall you will find at wall layout picture.

ATTENTION

Please be sure to avoid any naturally occurring knots in the timber when drilling and screwing, as this will cause you problems securing the screws.

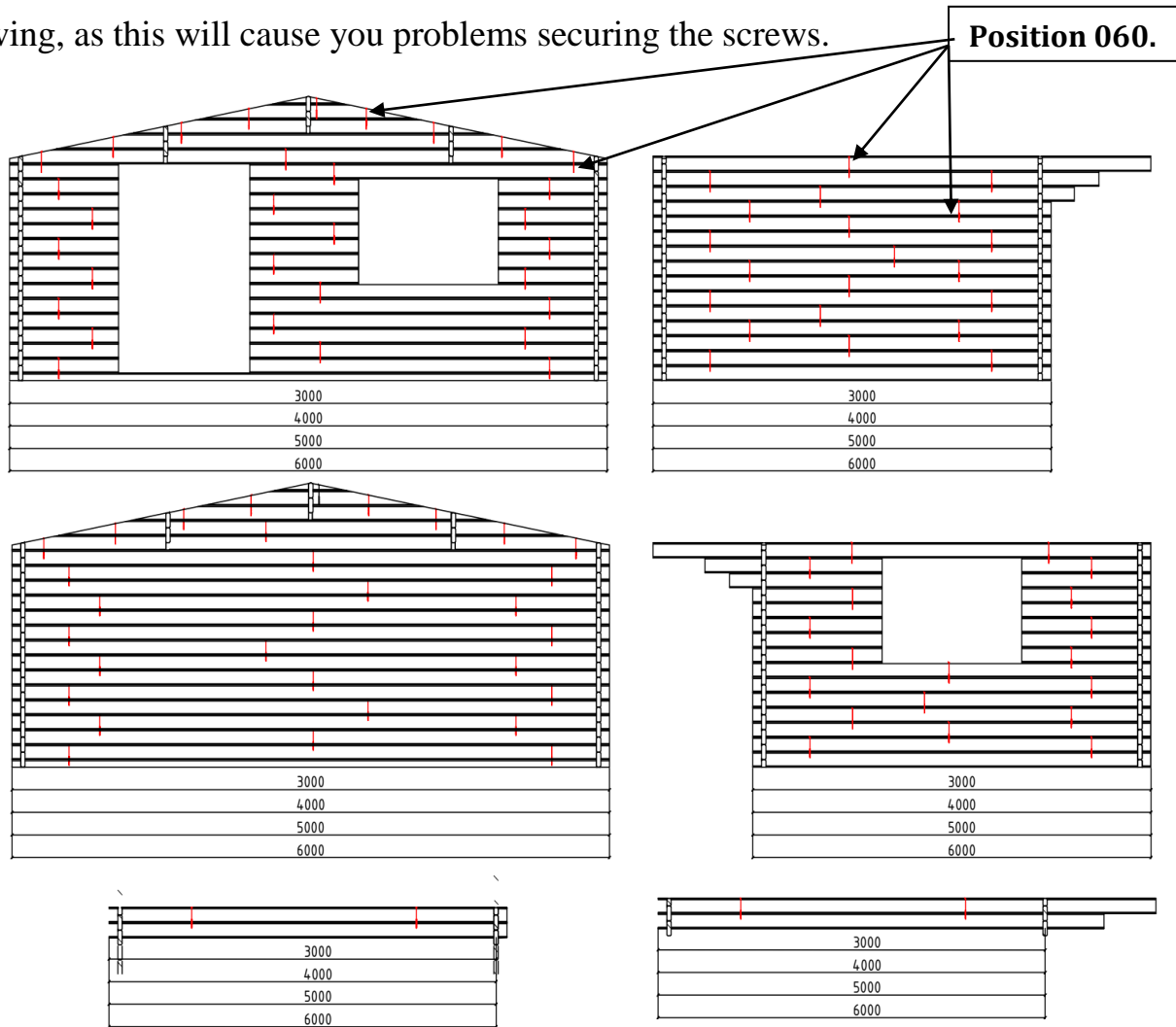

Make sure that the screw's are screwed in to the timber straight, and are slightly sunk below the level of the timber, this will ensure the boards butt together tightly.

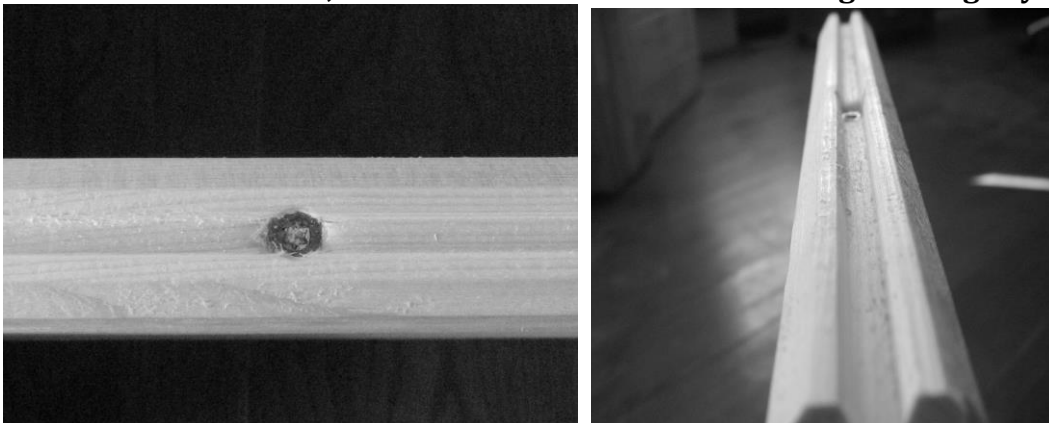

1. Take one wall log & one end corner piece.

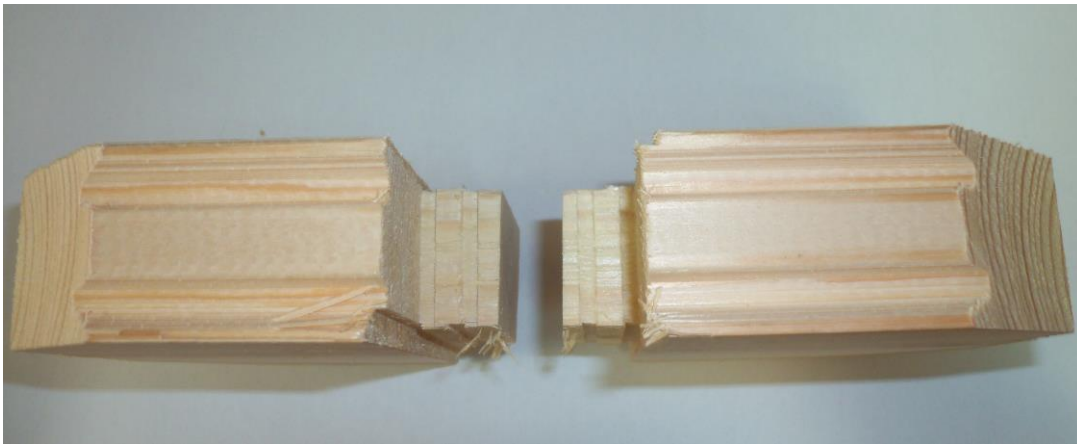

2. Push the ends of each piece up against each other as shown.

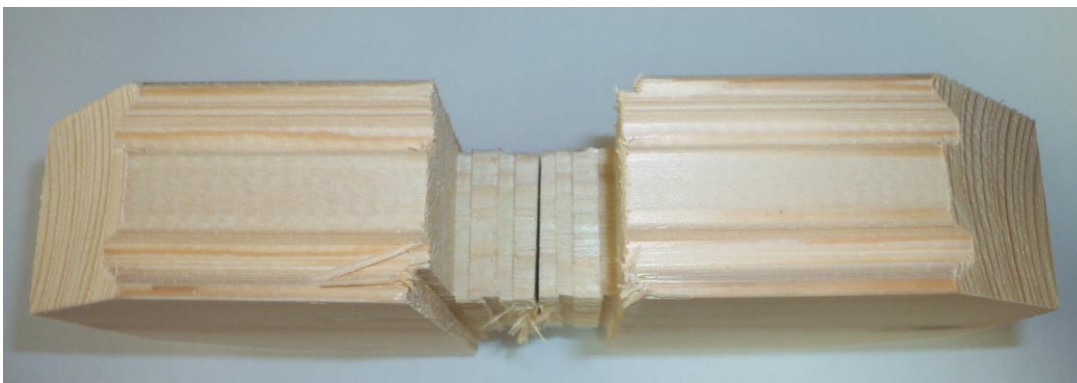

3. With both pieces together, fit the joining brackets to both the top and bottom of the joint as shown.

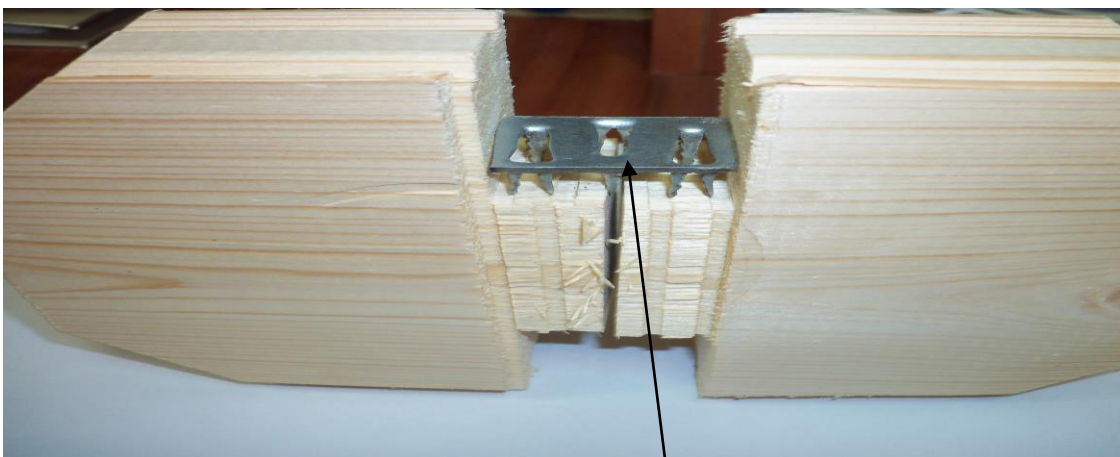

Pos. 054 Metal plates for wall

Ensure that joint is tight, and **that no gaps** are visible before placing joining bracket.

3a) View from underside

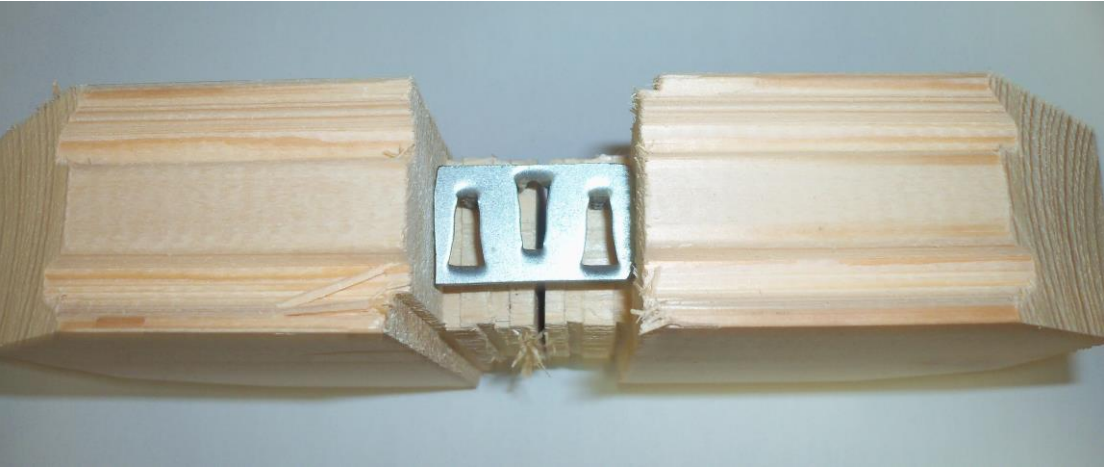

3b) View from top

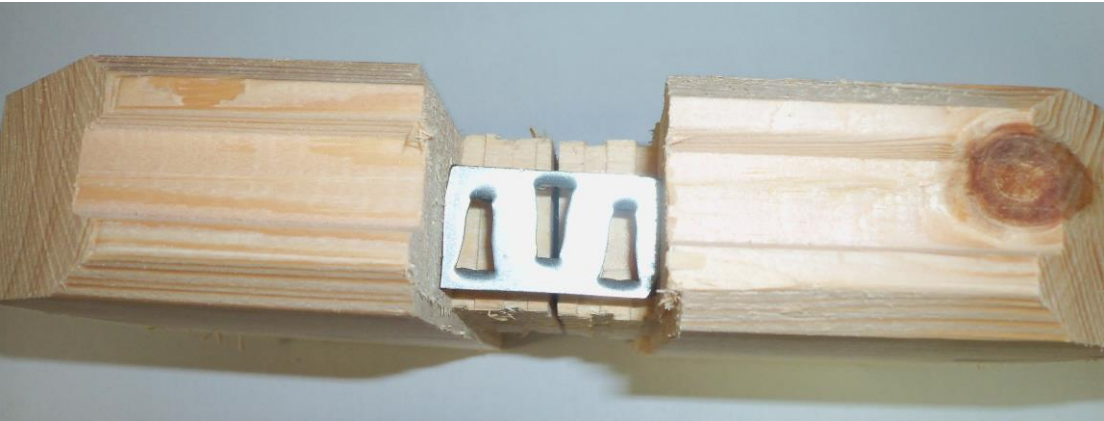

3c) This is how the finished joint should look.

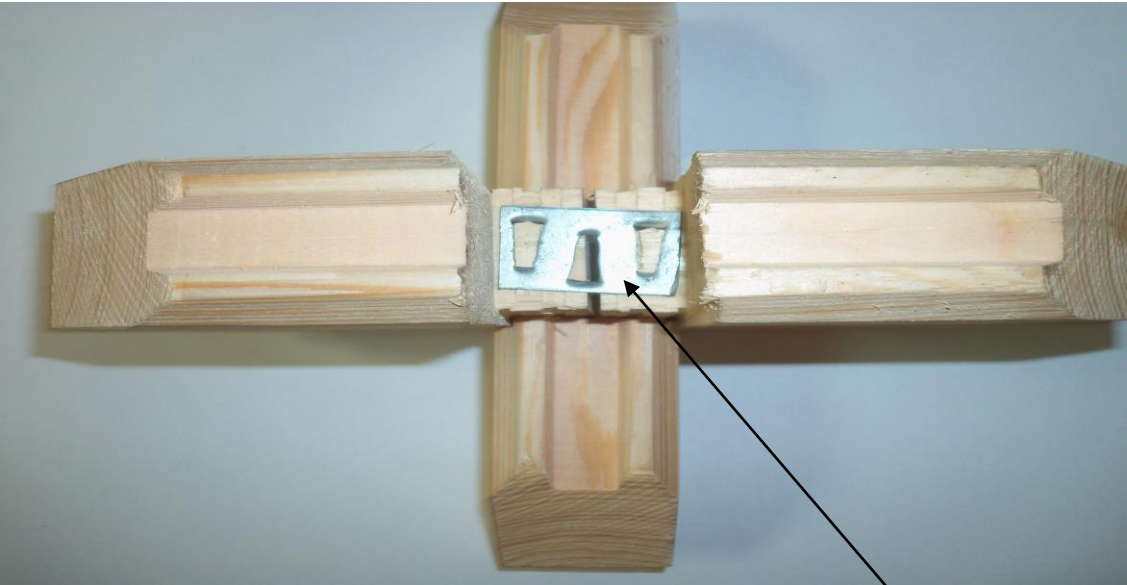

Pos. 054 Metal plates for wall

5. STEP

When you have built a house to 1/3 of the window height is starting to screw around windows and door strips, in order to put them into a house.

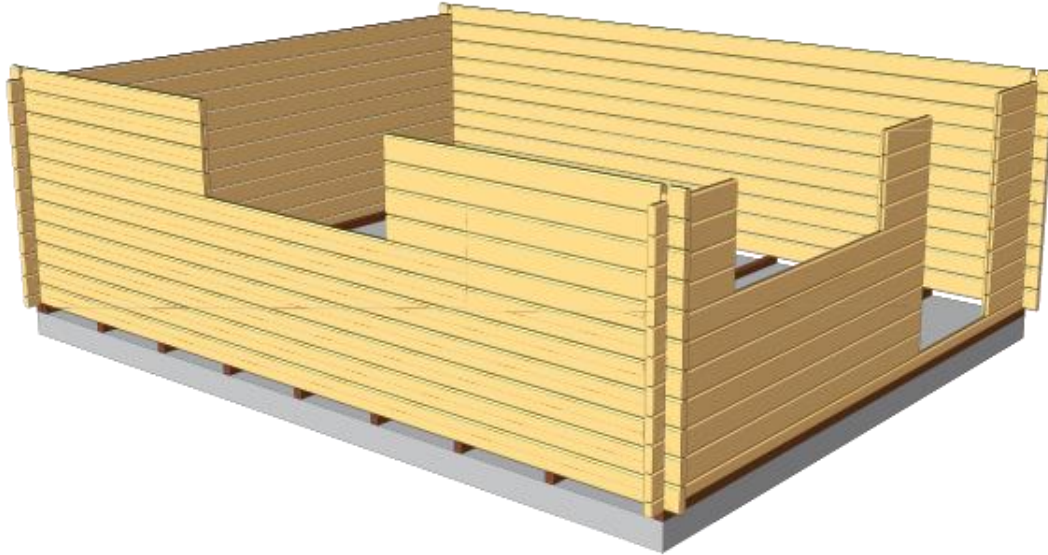

6. STEP

Screw up around window frames strips and screw up handles.

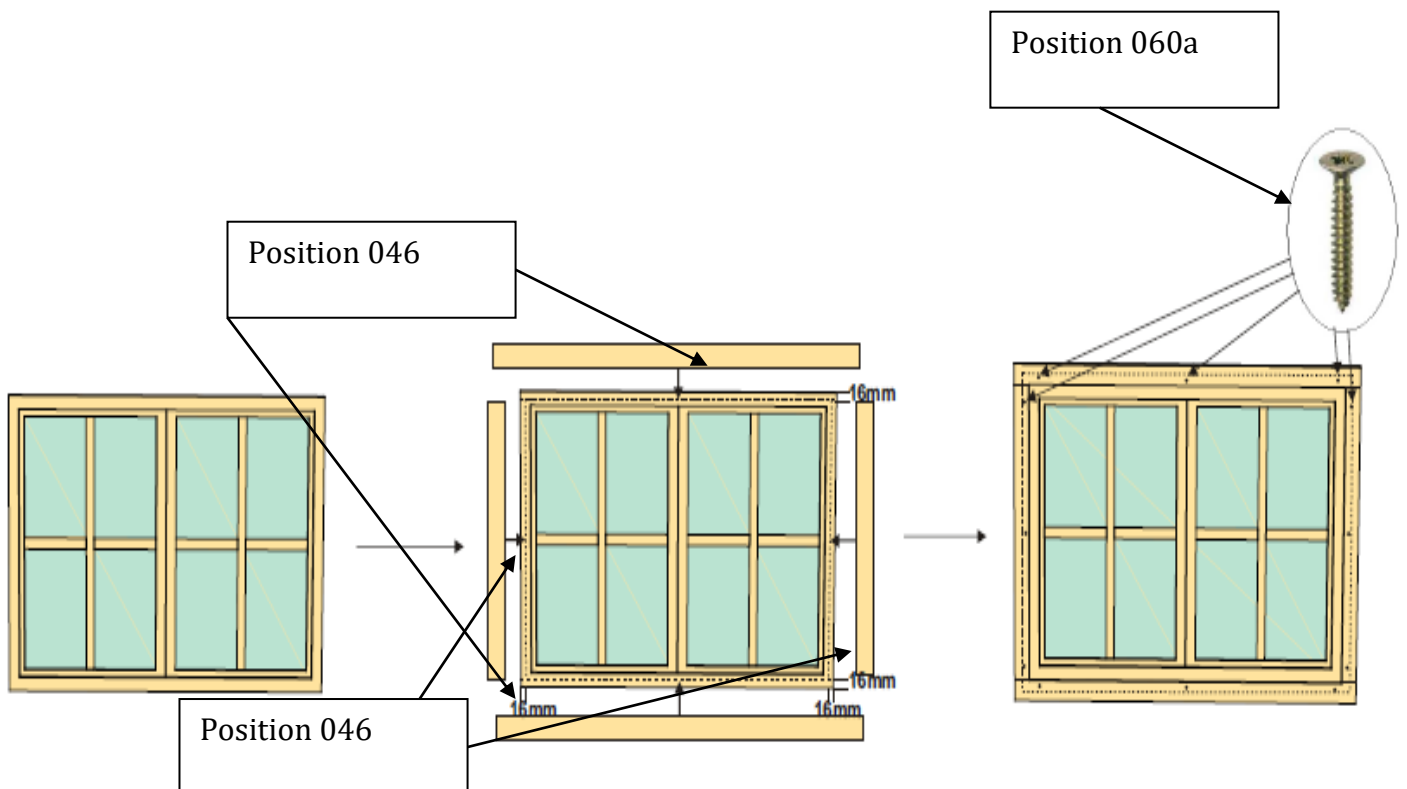

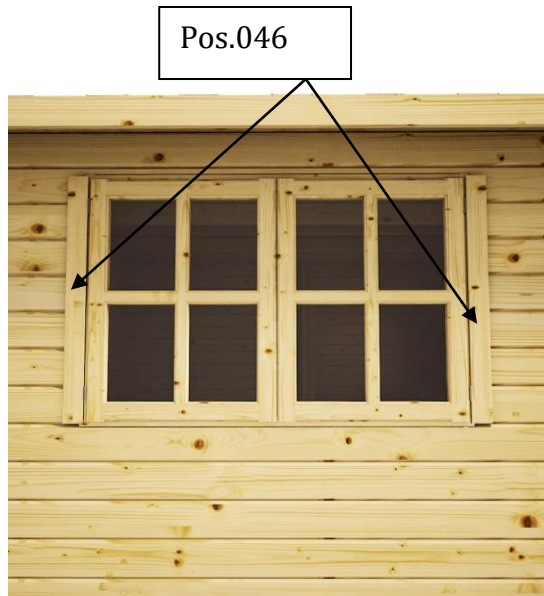
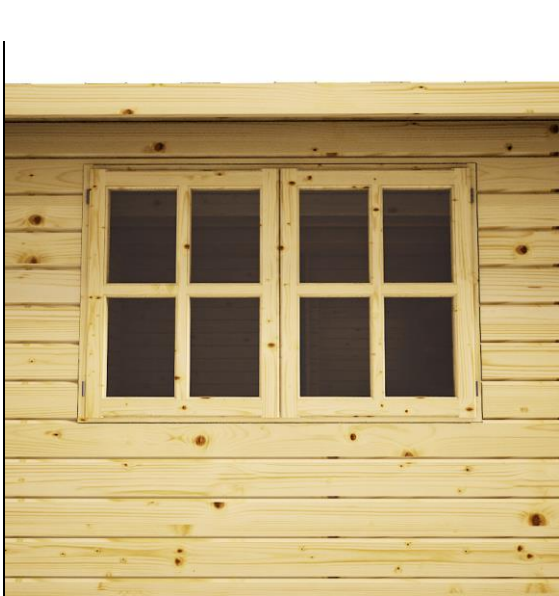

Pos.046

7. STEP

Screw up aruond door frames strips, put the lock and twisted handle.

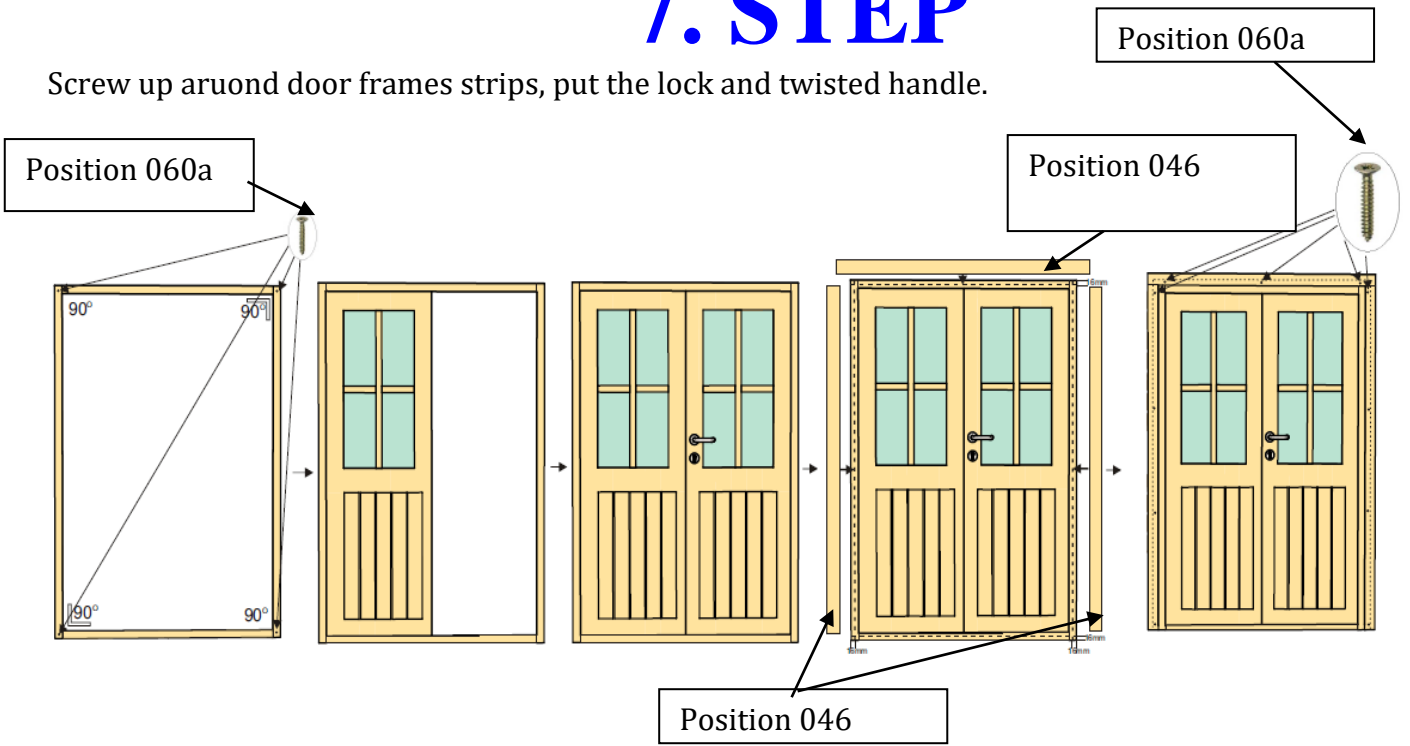

ATTENTION:

Door latches (zippers) should be at the side, as is shown in the photos (on the opposite side of the door lock).

View from inside door:



Door lock

Zippers

View from outside door:



Zipper must be on this side from inside

Door hinges

Hinge on door leaf

Door hinge view from outside

Hinge on door frame

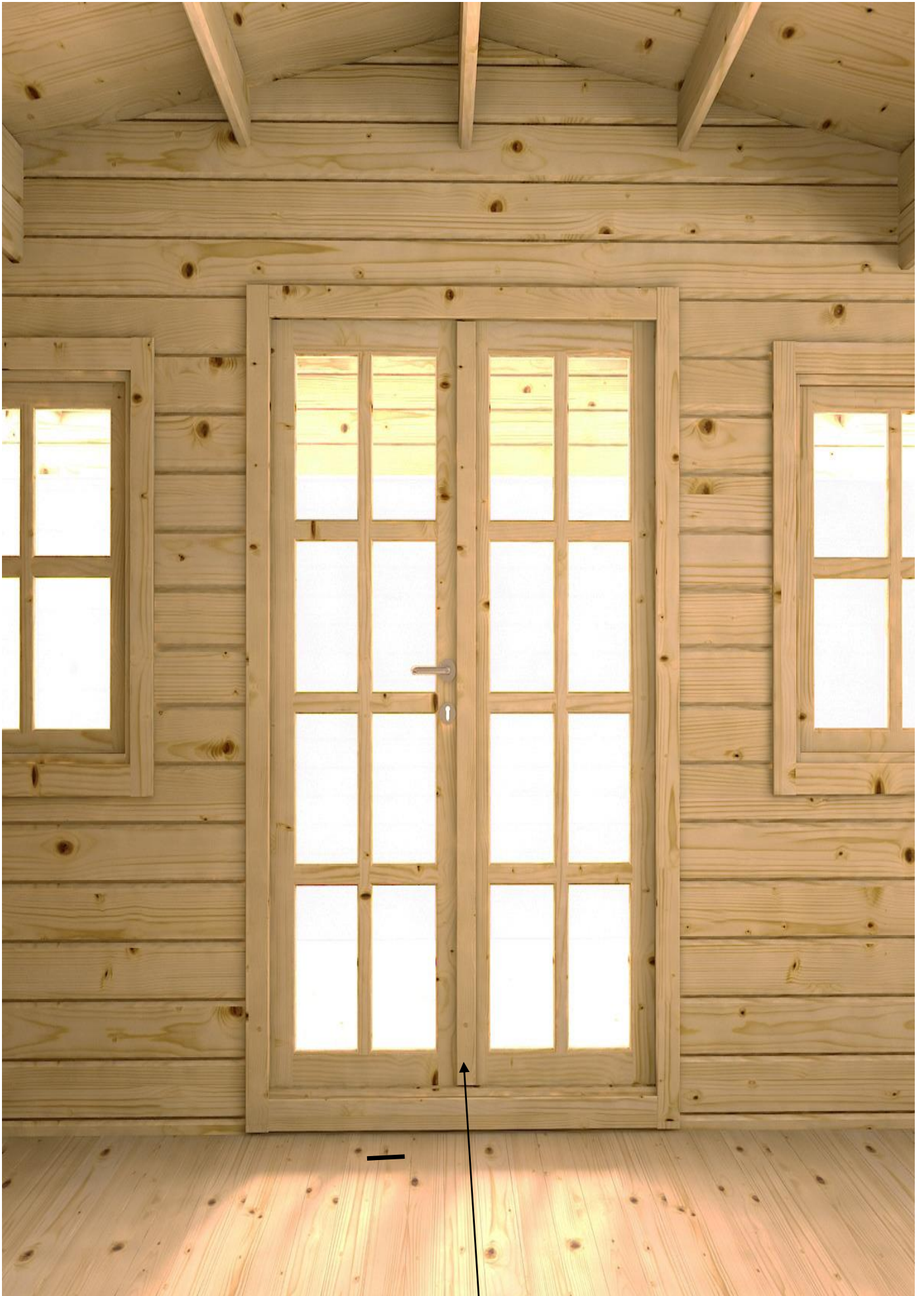

Position 043

8. STEP

Window frames and door frames which are screw up around strips , put in a constructive:

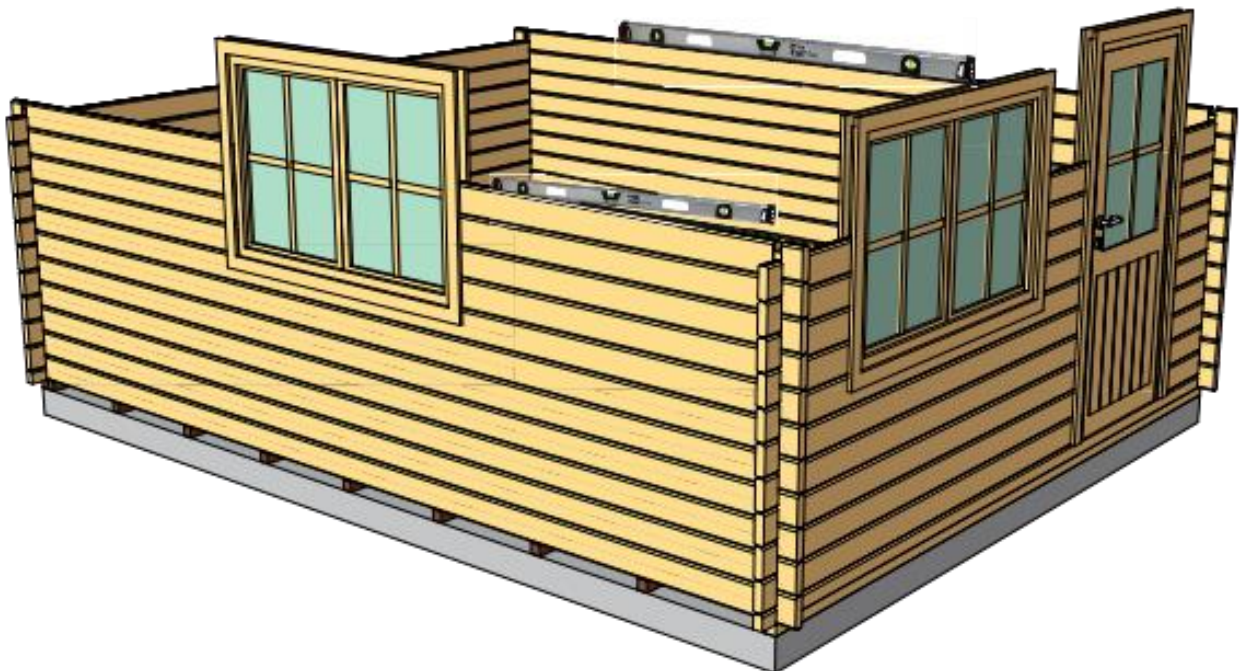
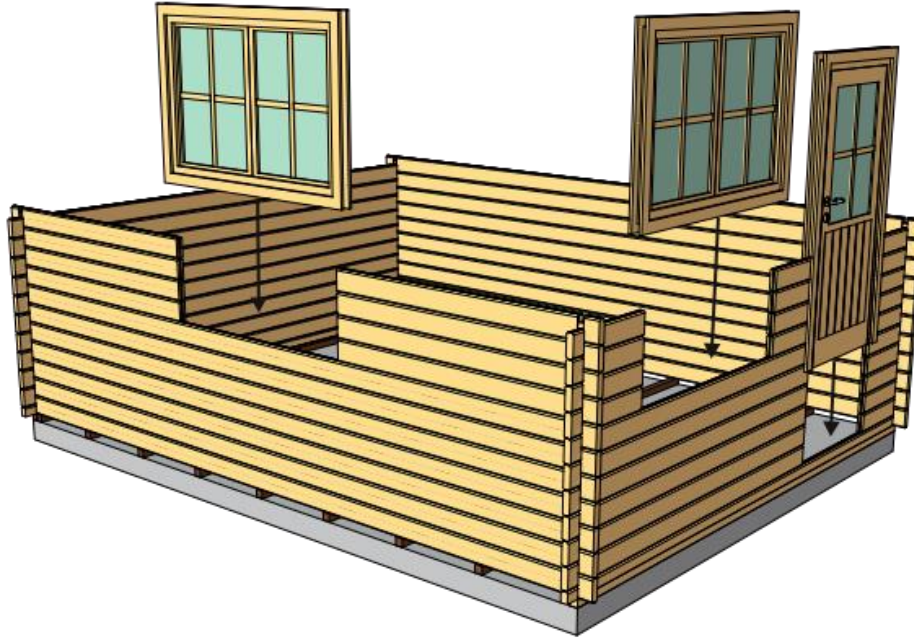

9. STEP

Fully completes the build's log house.



10. STEP

Roof boards installation:

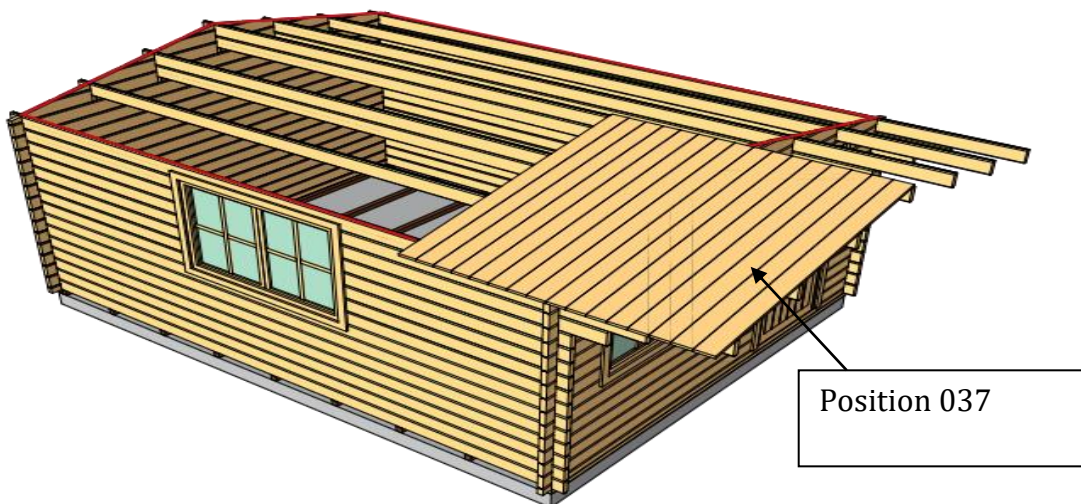

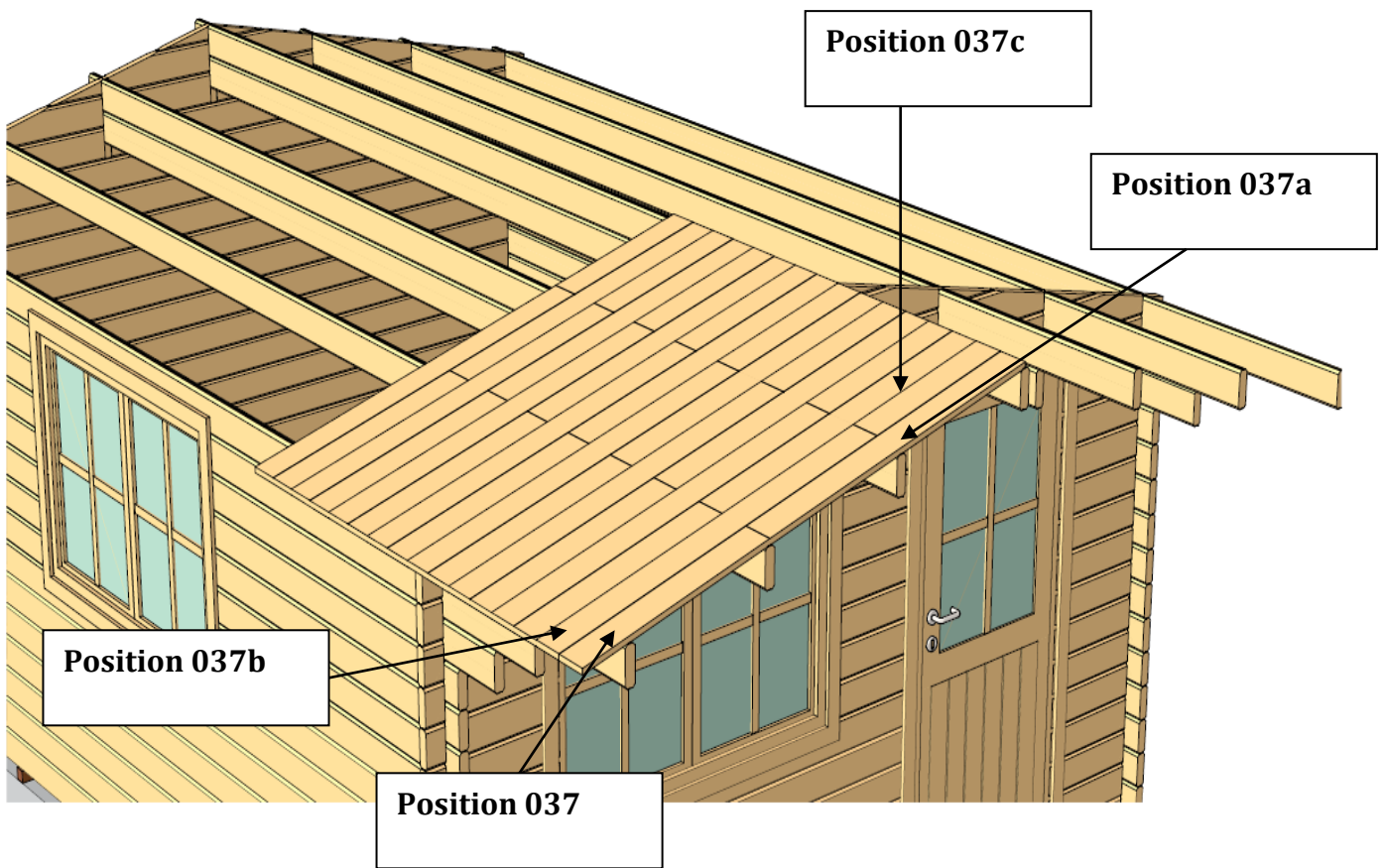

Pos. 074 must be put on the roof as it shown at the picture (please see example below). It must be nailed with 2x16 nail (see example for space between nails).

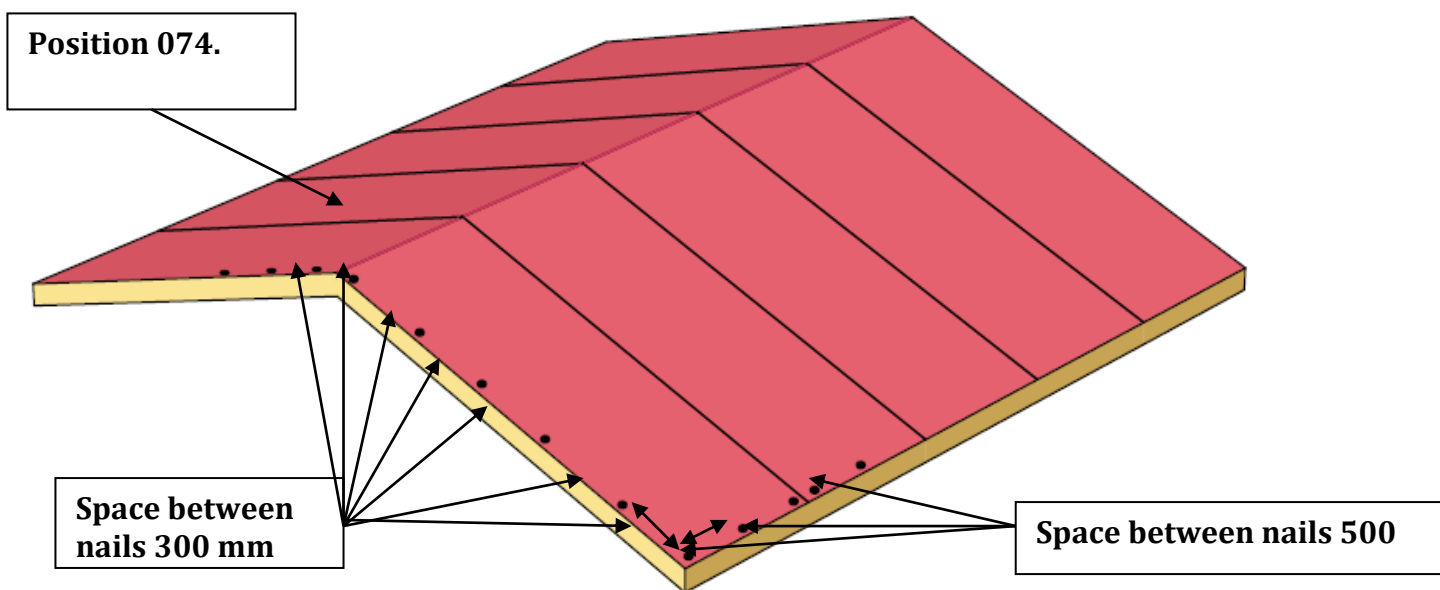

LOG CABIN SHINGLE TILE INSTRUCTION

ATTENTION:

We are not responsible for water leakages due to incorrect tile installation or improper preparation of the roof deck. Please therefore read these instructions carefully. If you have any installation questions please ask us before starting.

Sometimes a small deviation in colour of the tiles occurs between tiles in the same or different packs. This is not a defect of the material and is actually designed to increase the decorative beauty of the completed roof. In order to reduce colour difference during installation of the tiles, it is recommended to mix tiles from packs at random in order to create a mixed colour effect.

Storage:

Full pallets of tiles cannot be stored one on top of the other, otherwise this can compress the tiles into sticking to one another before use. In order to avoid shingles sticking to each other in a pack they should be protected from direct sunlight and any direct heat source. Each pack should be bent and shaken before opening, this helps to separate the shingles from each other.

It is not recommended to walk on the roof in hot/sunny weather because the cover might be damaged. Special ladders should be used for this purpose.

Usage of materials for roofing cover:

Each pack of bourne or hexham tiles contains 3 m² of tile coverage (including overlapping). Each pack of ridge tiles contains 5m² of tile coverage (including overlapping).

When calculating the amount of materials needed for roofing cover it is necessary to evaluate the quantity of tiles required depending on the complexity, degree of slope and size of the roof. Please remember to calculate extra tiles required for wastage (between 5 – 15% extra) as it is always better to have too many than too few tiles. Extra spare tiles, if stored correctly, can be used to repair any areas of damage in the future.

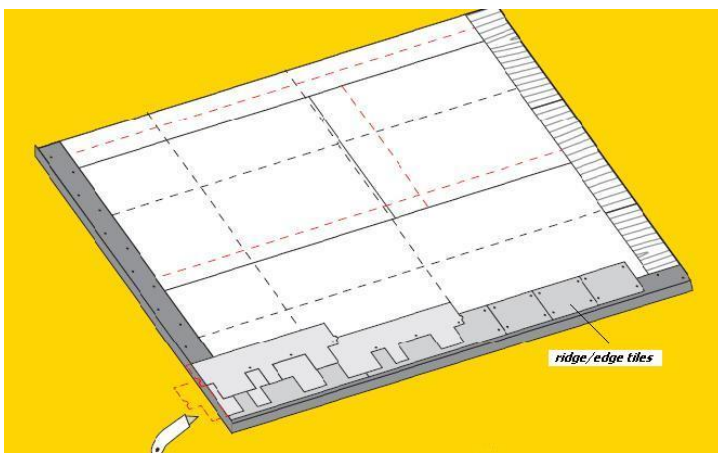

Installation of bitumen shingles: Initial row (tiles of ridges/cornice):

Ridge/cornice tiles or the usual tiles (with the jagged edge cut off) are used for the initial row of tiles along both the eaves of the roof as well as the pitched cornice at the top.

The silicon film should be removed from the under side of the tile prior to installation.

Every tile should be nailed to the roof boards with wide headed galvanized roof tack nails. The number of nails depends on the pitch or slope of your roof. It is very important not to over hit the nails. They should be nailed in such a way that the head of the nail head is flush with the tile and not below the surface. The head of the nail should not puncture the surface of the shingle tile.

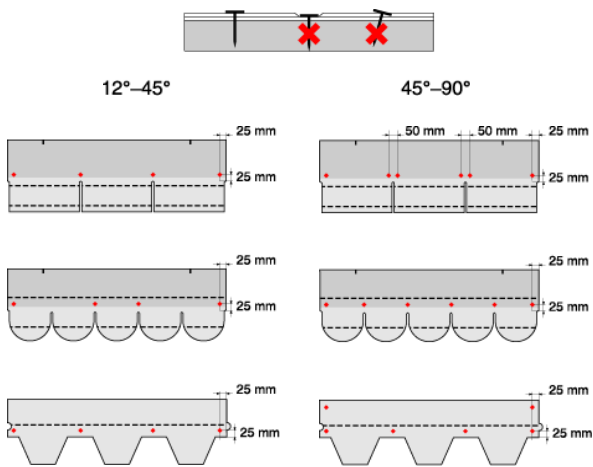

The nails are put 2 – 3 cm from the edge of the tile. Picture on the left indicate the number of nails needed and where they should be applied at certain roof angle. The picture shows the topside of the tile, and the dotted line indicates the place of the adhesive bottom layer.

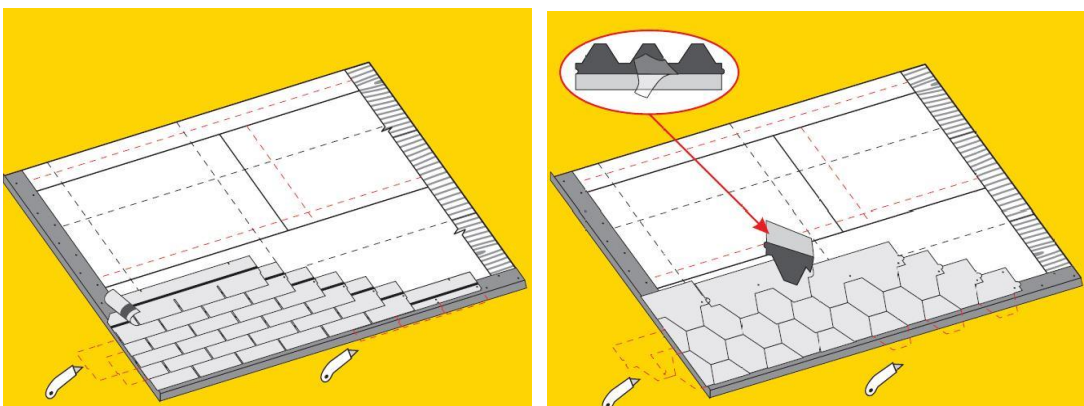

Ridge/cornice tiles should be cut into three parts at the places of perforation and laid in a straight line with an overlap of 3 – 5 cm. They are fixed with two nails on each side of the slope.

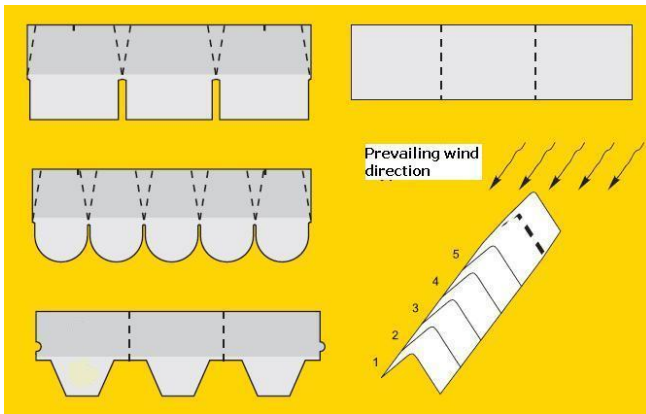

Installation should be performed against the prevailing direction of the wind.

ATTENTION: if ridge – cornice tiles are outside temperature lower than 10°C it to bend them on a heated 10 cm diameter avoid cracks. (See the picture on the left)

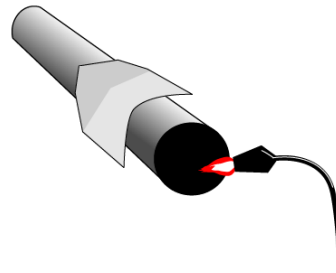

installed at the is recommended tube in order to

Ventilation:

The durability of the roof construction is longer if the roof has proper ventilation, especially over the usable attic.

Tile Patterns:

Please make sure that the individual tiles are NOT overlapped to cover the darker colour section. Please refer to the pictures for the correct spacing of tiles. If you assemble the tiles with a larger overlap than recommended you will not have enough tiles to complete your roof. We provide the correct quantity of tiles in order to cover your roof according to correct assembly.

We strongly recommend to use wide headed (up with 15-19 mm long) nails to fix the bitumen tiles.

If you are going to put the tiles at lower than +15 degrees outside temperature, please preheat black sealing belt zones or use extra mastics to ensure waterproofing. In this case also recommend to keep tiles in warm temperature (inside) for 24 hours before installation.

The cost of extra tiles and delivery will be paid for by the customer.

HEXHAM TILES PATTERN

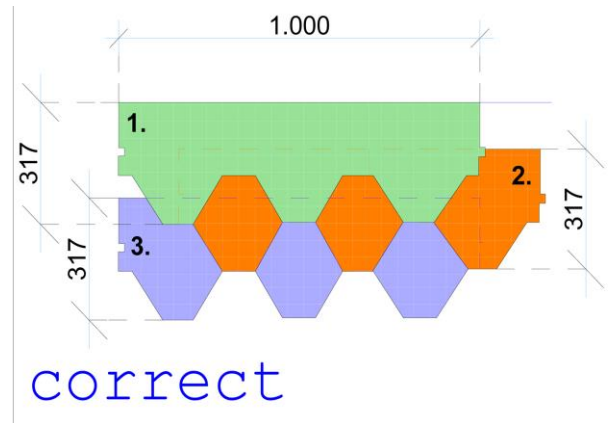
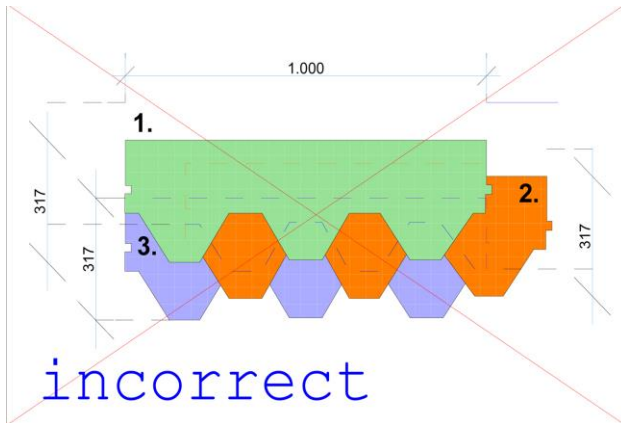

BOURNE TILE PATTERN

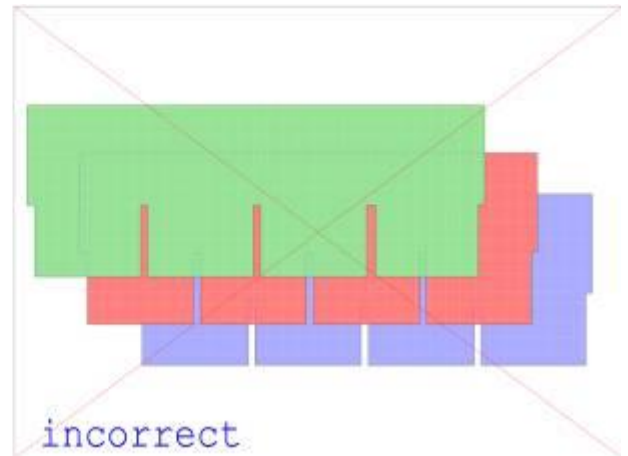
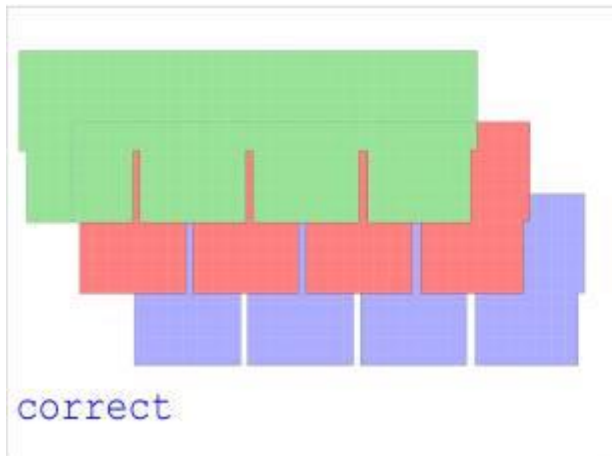

If you have any questions about the installation process of your tiles please call to ask before starting.

ATTENTION:

We are not responsible for water leakages due to incorrect tile installation or improper preparation of the roof deck. Please therefore read these instructions carefully. If you have any installation questions please ask us before starting.

11. STEP

Fascia board, fascia board strip and roof strip installation procedures :

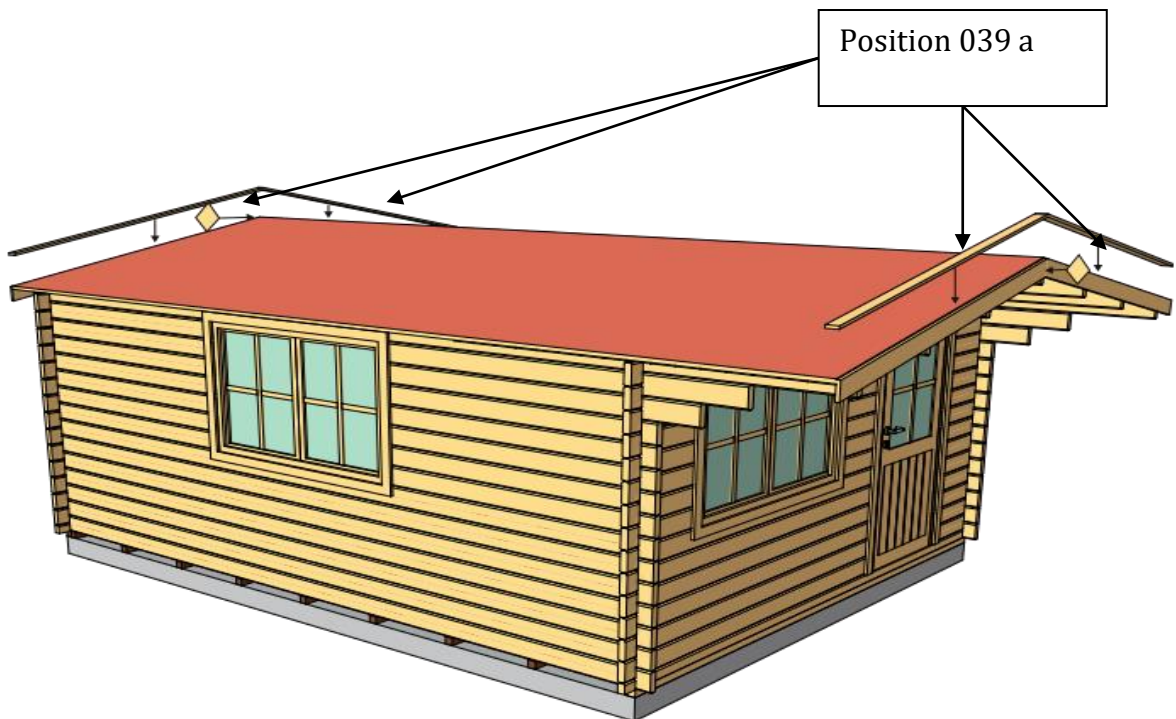
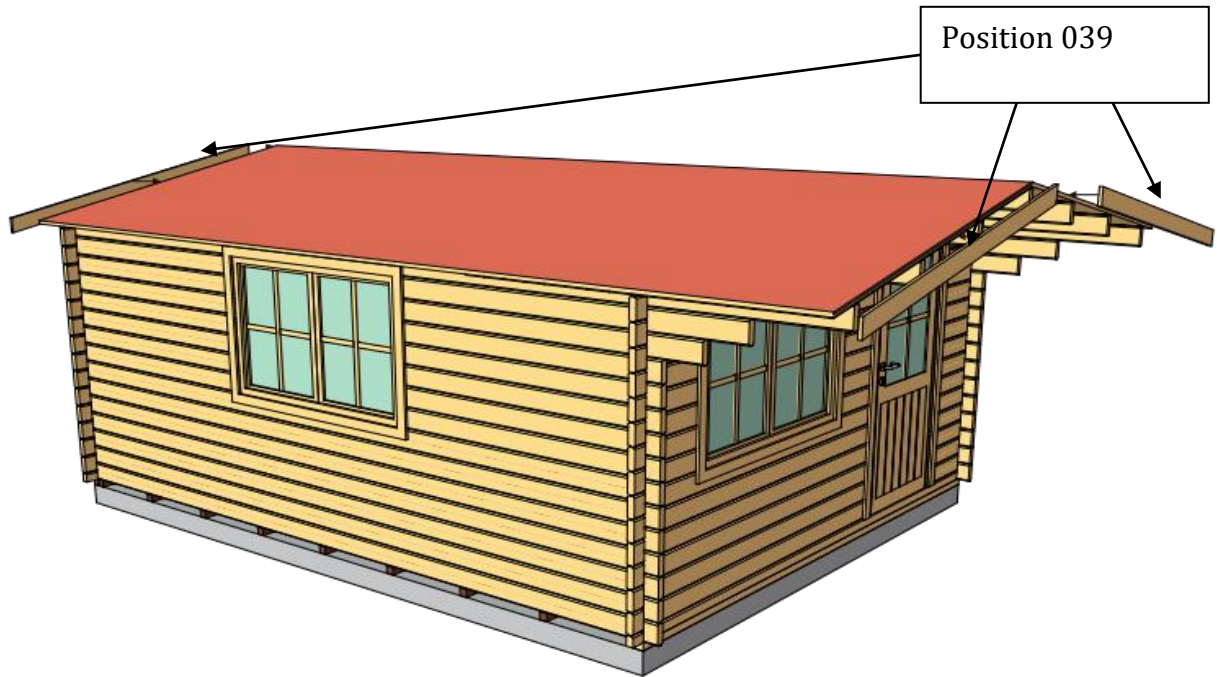

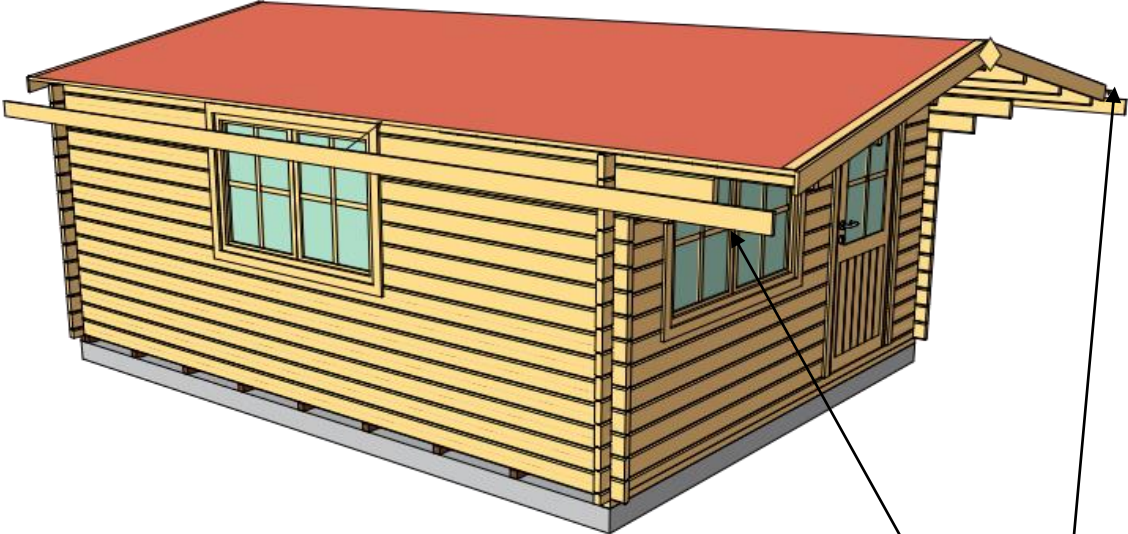

Position 039 b

12. STEP

Floor boards installation:

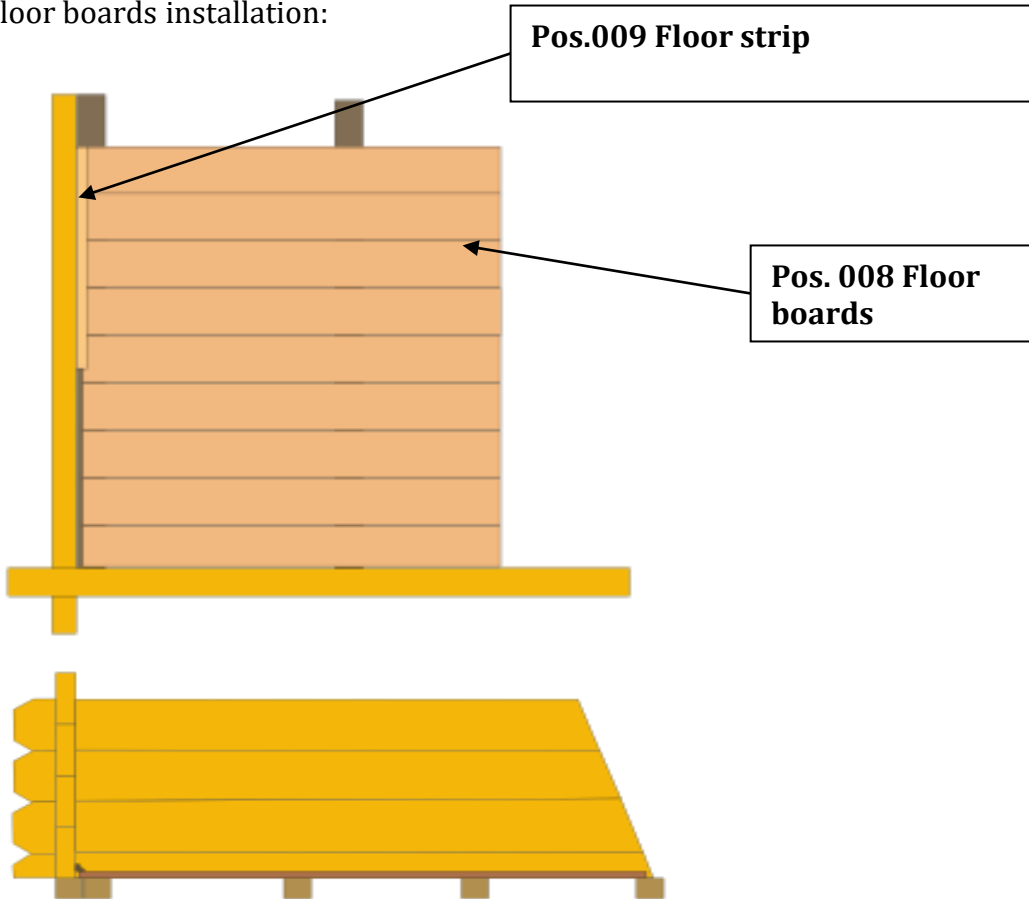

13. STEP

Pos. 010 Strip for inside roof – to cover openings between apex and wall boards.

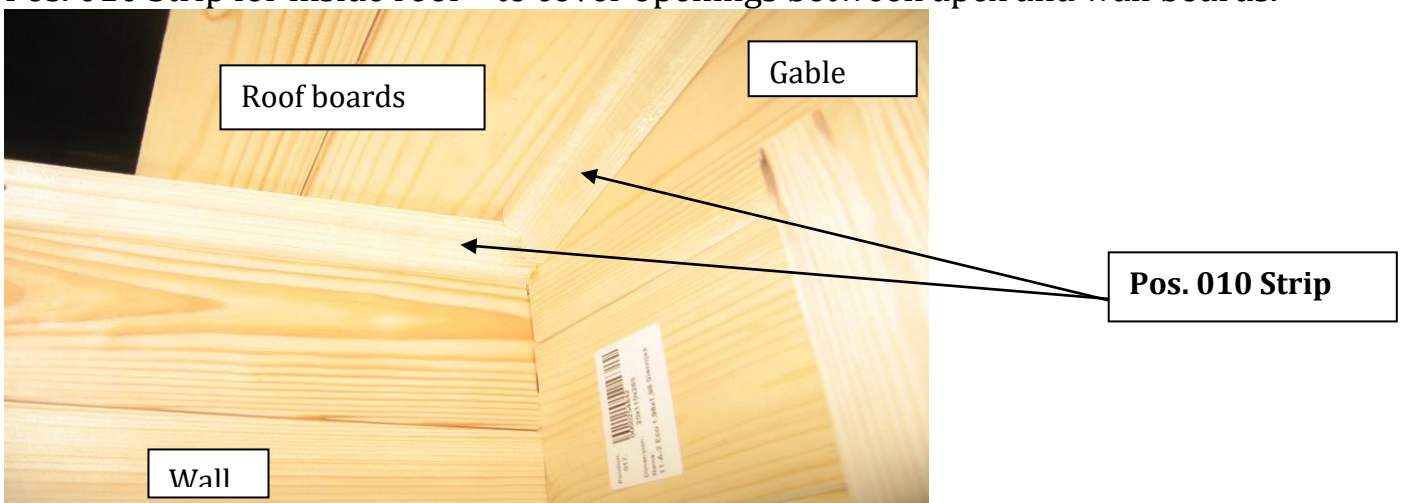

III. Quality certification and product maintenance after the installation configuration

III.A. Control Certificate

The house you have purchased was manufactured in accordance with the high quality norms. The building unit has been carefully inspected and packed. In order to avoid possible during the assembly carried out by yourself or the building company of your choice, we recommend that you inspect the delivery for its completeness in accordance with the list of the pieces before assembly. This inspection must be carried out within 14 days after delivery to your place. Warrantly claims are limited to the exchange of defective materials. Defective building parts, which have already been used or painted, are excluded from being replaced. All further claims are excluded! In cases of complaints, please pay attention to the following procedures : Please present this inspection certificate along with the sales receipt to your place of purchase. Only in cases where these documents are presented will the complaint be dealt with quickly and without complications.

Unique number:

If you have any questions please contact with us per e-mail: support@eurowood.lt

Cabin model: _____

Pos.number from list of detał	Measurment	Quantity	Reason for request