

Somers TC438 : G.Adv

Ground plan

2
SHEET

7
OF

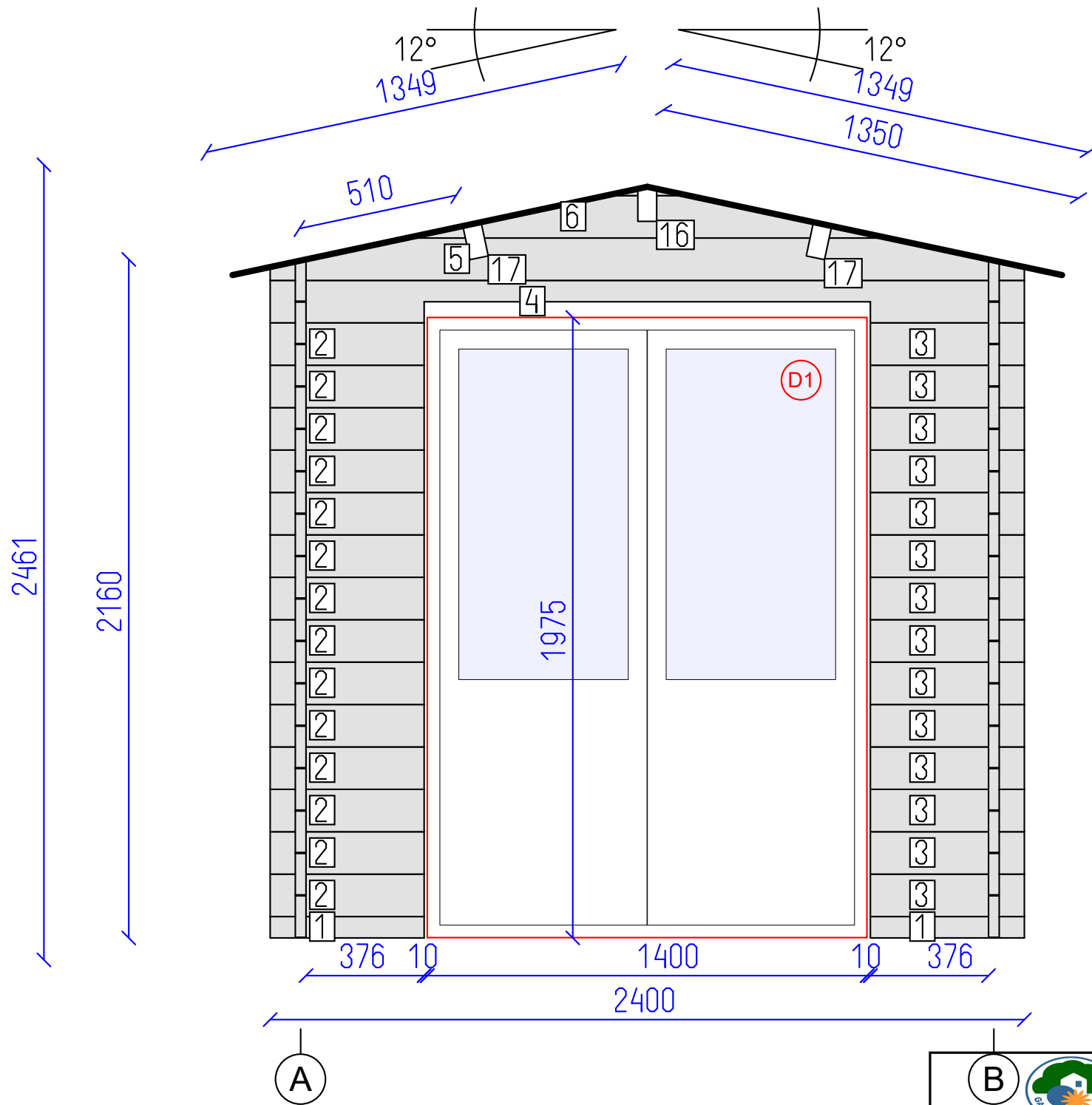

DETAILS

N	QTY
1	2
2	14
3	14
4	1
5	1
6	1
16	1
17	2

- LIST OF ELEMENTS
- 1. Wall 68x34x490
 - 2. Wall 135x34x490
 - 3. Wall 135x34x490
 - 4. Wall 135x34x2400
 - 5. Wall 135x34x2400
 - 6. Wall 135x34x1532
 - 16. Roof beam 140x70x4420
 - 17. Roof beam 140x70x4420
- Total 4.63 m²

Somers TC438 : G.Adv

Wall 1	---	3	7
		SHEET	OF



2160

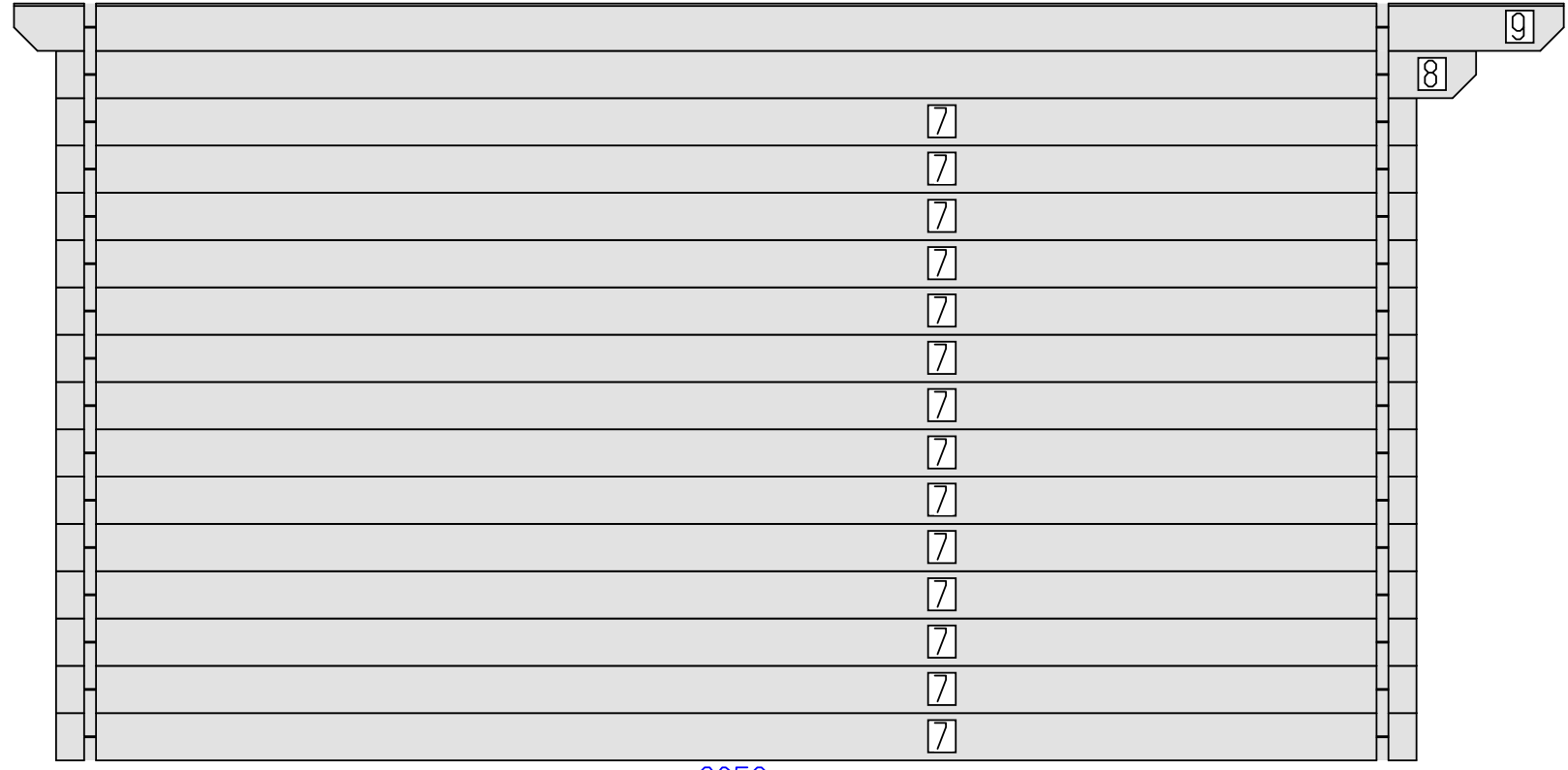

3652

3880

2

1

DETAILS

N	QTY
7	14
8	1
9	1

LIST OF ELEMENTS

- 7. Wall 135x34x3880
 - 8. Wall 135x34x4050
 - 9. Wall 135x34x4420
- Total 8.48 m²

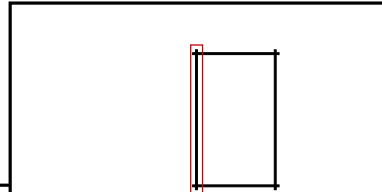

Somers TC438 : G.Adv

Wall A

4

7

SHEET

OF

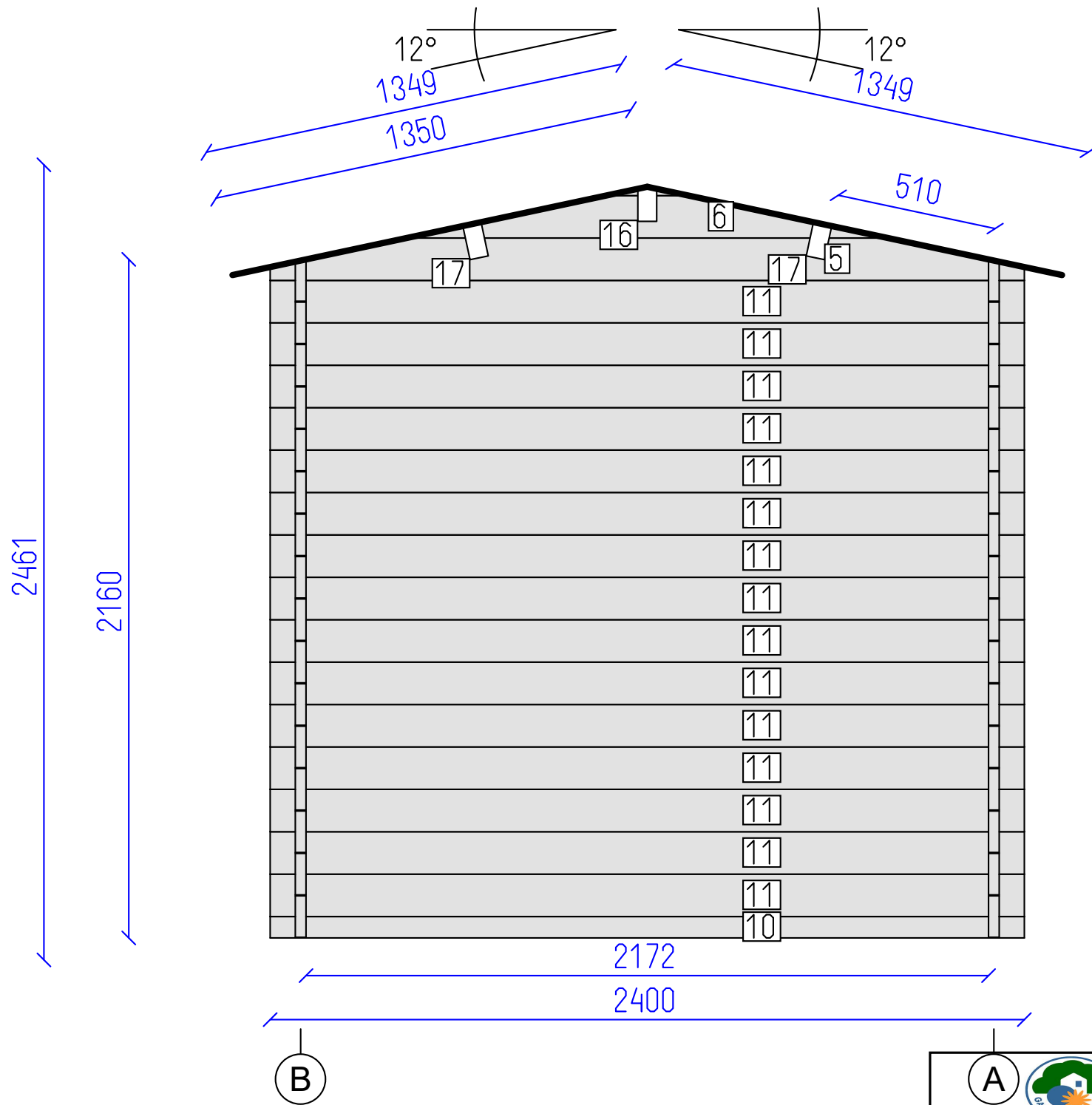

DETAILS

N	QTY
10	1
11	15
5	1
6	1
16	1
17	2

LIST OF ELEMENTS

- 10. Wall 68x34x2400
 - 11. Wall 135x34x2400
 - 5. Wall 135x34x2400
 - 6. Wall 135x34x1532
 - 16. Roof beam 140x70x4420
 - 17. Roof beam 140x70x4420
- Total 7.41 m²

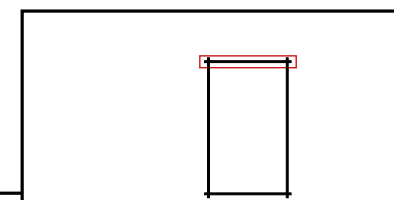

Somers TC438 : G.Adv

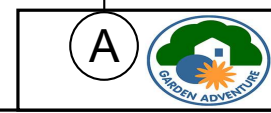

DETAILS

N	QTY
7	7
12	7
13	8
14	1
15	1

LIST OF ELEMENTS

- 7. Wall 135x34x3880
 - 12. Wall 135x34x1230
 - 13. Wall 135x34x1230
 - 14. Wall 135x34x1400
 - 15. Wall 135x34x4420
- Total 6.94 m²

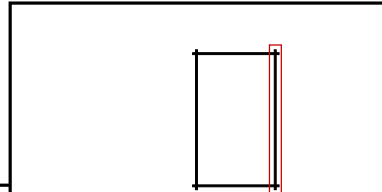
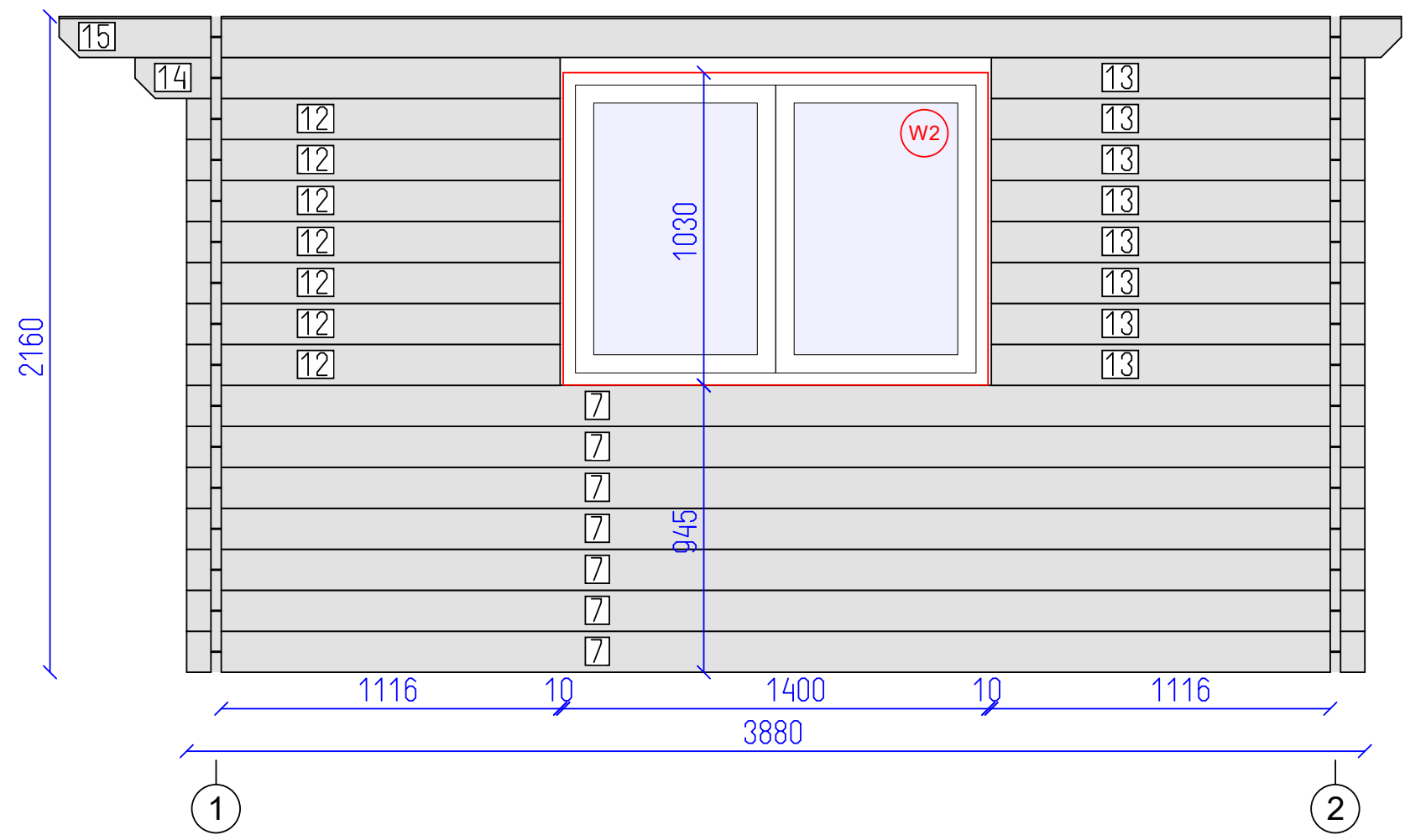

Somers TC438 : G.Adv



