



Livigno 44

Tikr.

Dare
AND

1
SHEET

8
OF

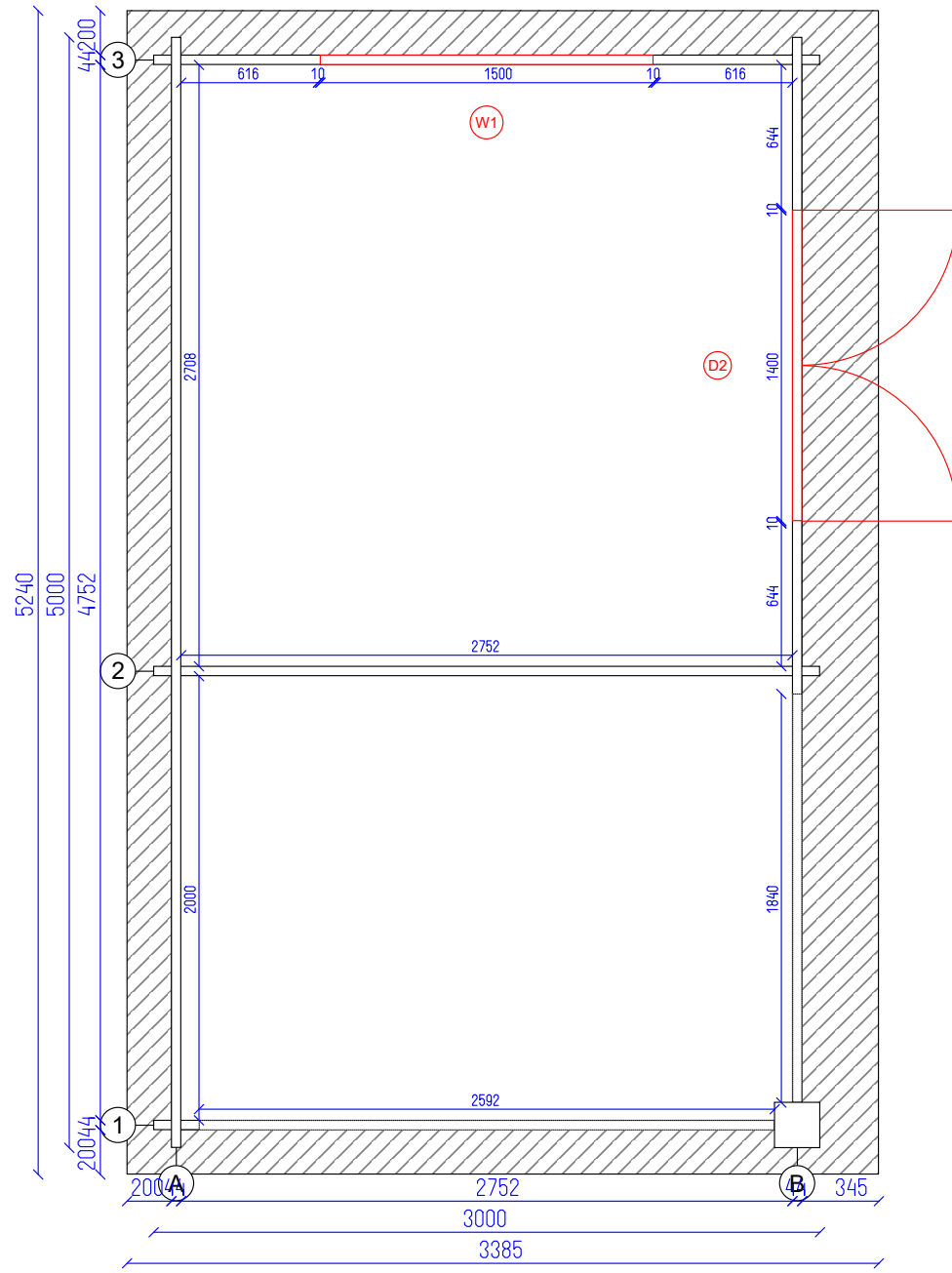

Livigno 44

Ground plan

Tikr.

Dare
AND

2
SHEET

8
OF

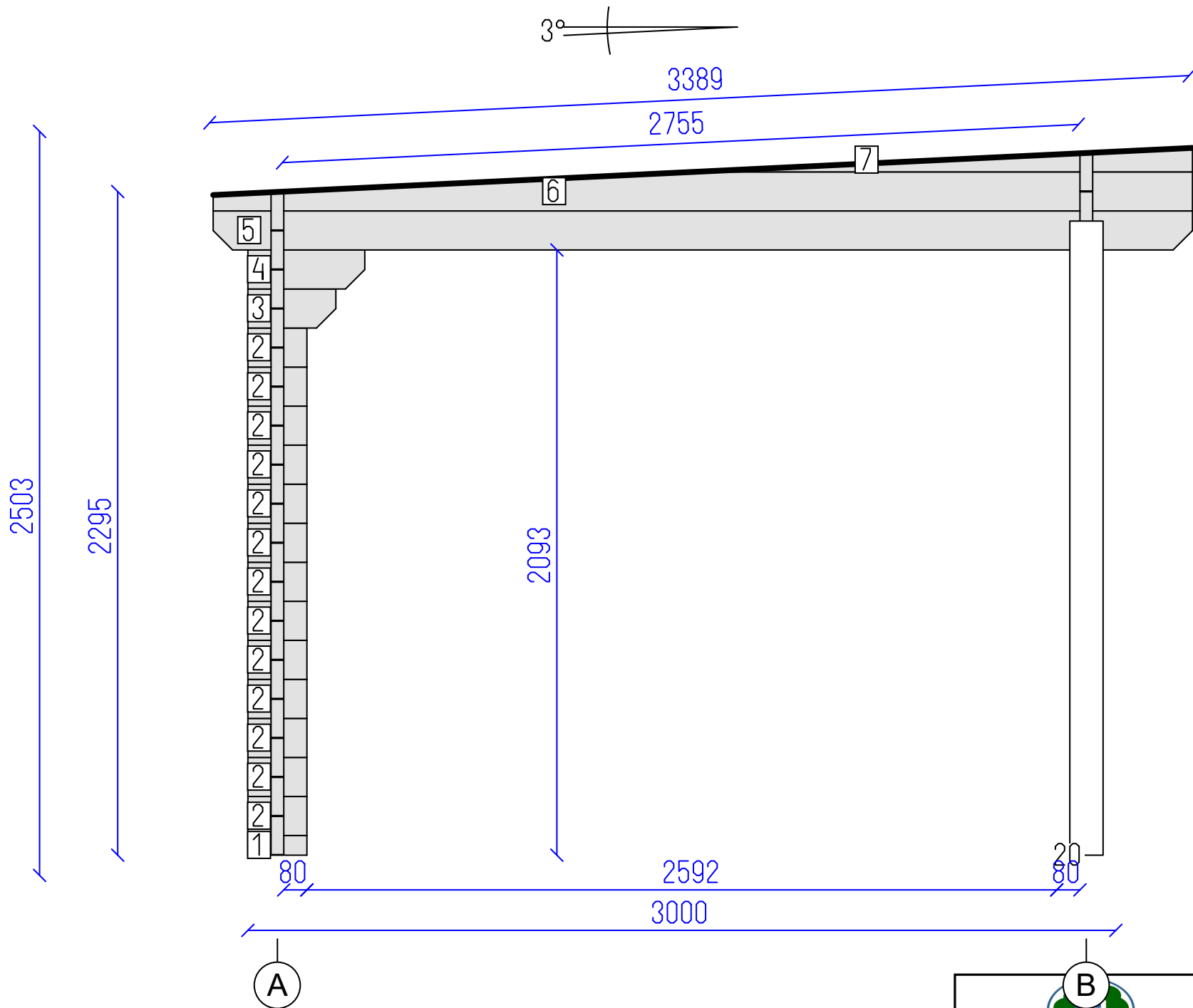

DETAILS

N	QTY
1	1
2	13
3	1
4	1
5	1
6	1
7	1
20	1

LIST OF ELEMENTS

- 1. Wall 68x44x204
 - 2. Wall 135x44x204
 - 3. Wall 135x44x304
 - 4. Wall 135x44x404
 - 5. Wall 135x44x3385
 - 6. Wall 135x44x3385
 - 7. Wall 83x44x1724
 - 20. Post 115x115x2193
- Total 1.78 m²

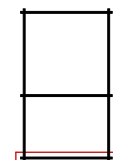

Livigno 44

Wall 1	Tikr. ---	Dare AND	3 SHEET	8 OF
--------	--------------	-------------	------------	---------



DETAILS

N	QTY
8	16
9	1
21	4

LIST OF ELEMENTS

- 8. Wall 135x44x5000
- 9. Wall 135x44x5000
- 21. Roof beam 140x44x3395
- Total 13.38 m²

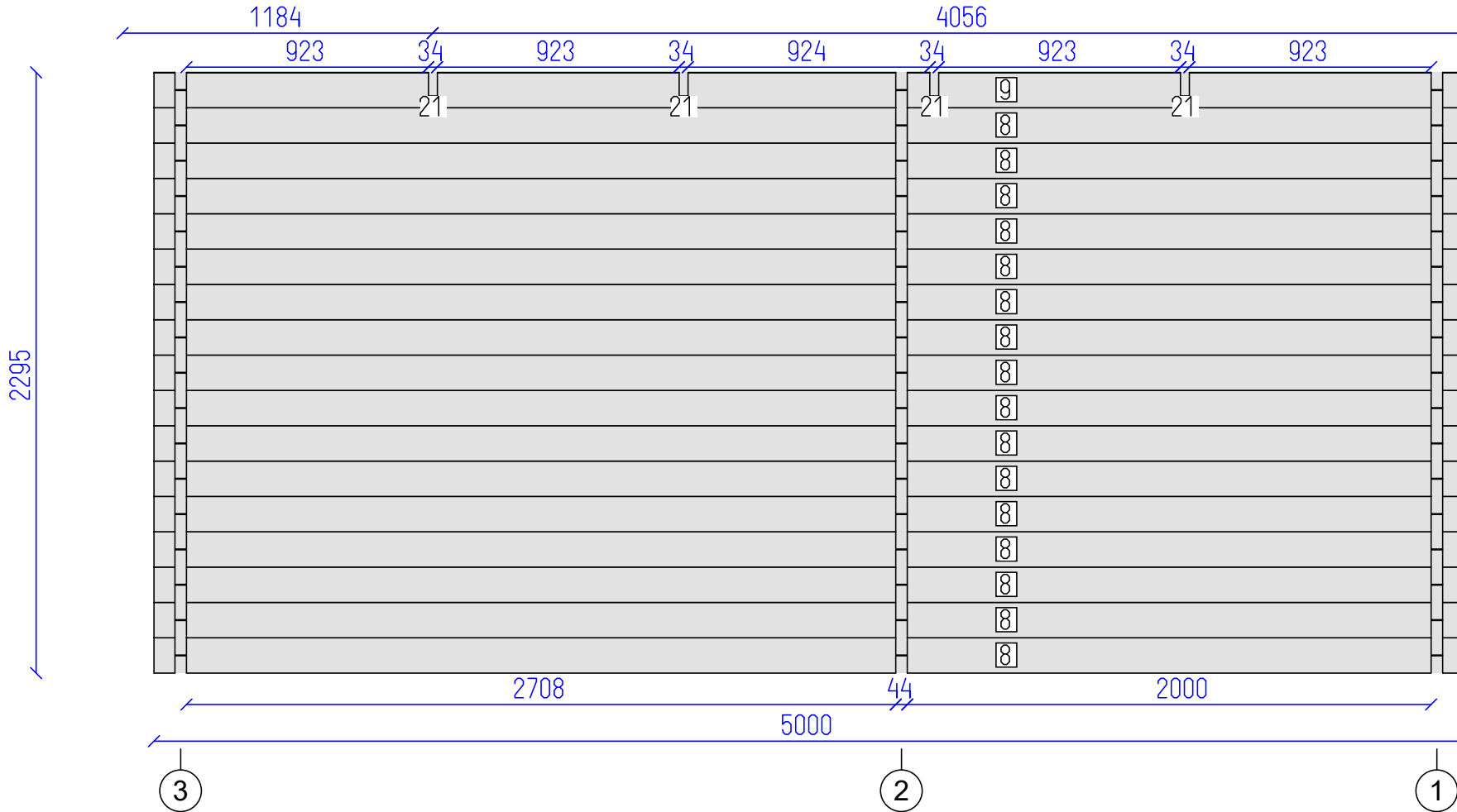

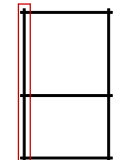

Livigno 44

Wall A	Tikr. ---	Dare AND	4 SHEET	8 OF
--------	--------------	-------------	------------	---------

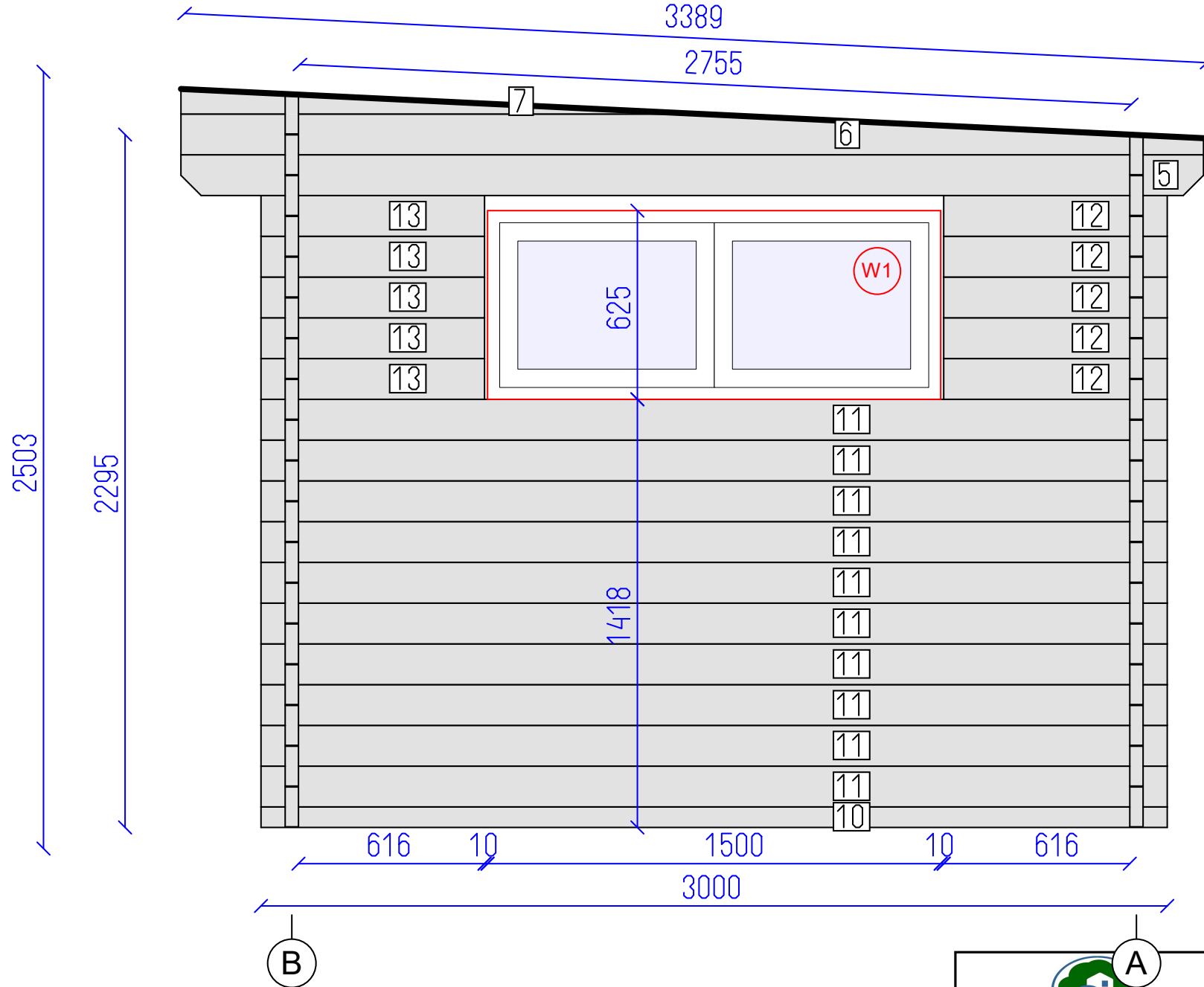
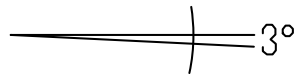

DETAILS

N	QTY
10	1
11	10
12	5
13	5
5	1
6	1
7	1

LIST OF ELEMENTS

- 10. Wall 68x44x3000
 - 11. Wall 135x44x3000
 - 12. Wall 135x44x740
 - 13. Wall 135x44x740
 - 5. Wall 135x44x3385
 - 6. Wall 135x44x3385
 - 7. Wall 83x44x1724
- Total 6.31 m²

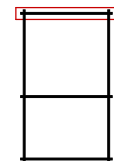

Livigno 44

Wall 3	Tikr. ---	Dare AND	5 SHEET	8 OF
--------	--------------	-------------	------------	---------



DETAILS

N	QTY
14	15
15	15
16	1
8	1
17	1
20	1
21	4

LIST OF ELEMENTS

- 14. Wall 135x44x768
 - 15. Wall 135x44x768
 - 16. Wall 135x44x2956
 - 8. Wall 135x44x5000
 - 17. Wall 134x44x5000
 - 20. Post 115x115x2193
 - 21. Roof beam 140x44x3395
- Total 7.01 m²

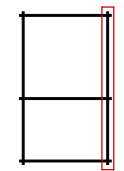
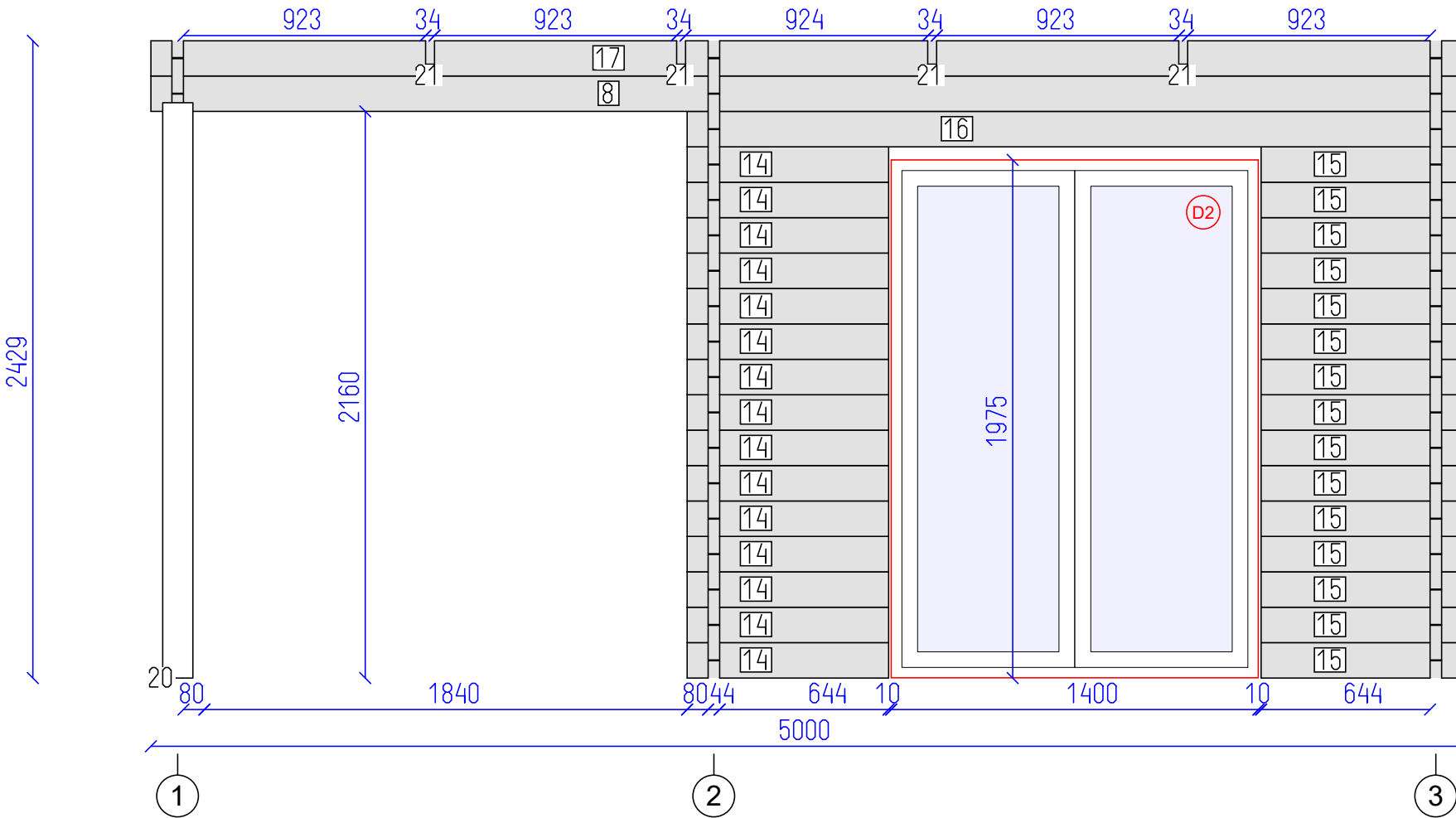

Livigno 44

Wall B

Tikr.

Dare
AND

6
SHEET

8
OF



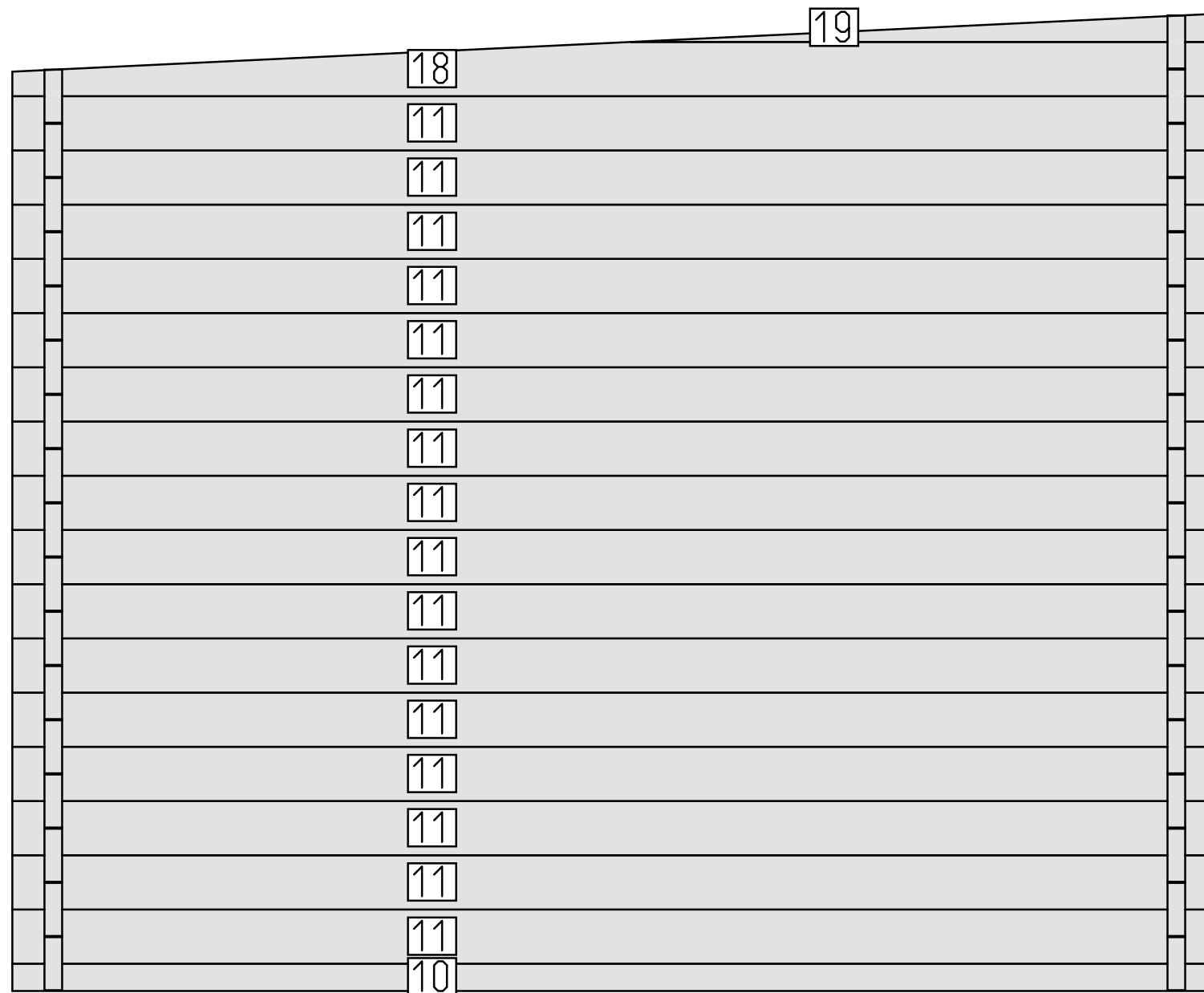

DETAILS

N	QTY
10	1
11	16
18	1
19	1

LIST OF ELEMENTS

- 10. Wall 68x44x3000
- 11. Wall 135x44x3000
- 18. Wall 135x44x3000
- 19. Wall 70x44x1459
- Total 7.19 m²

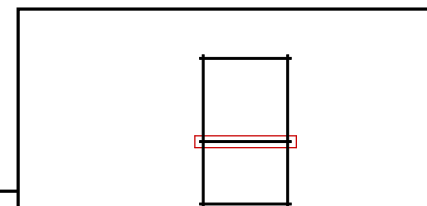
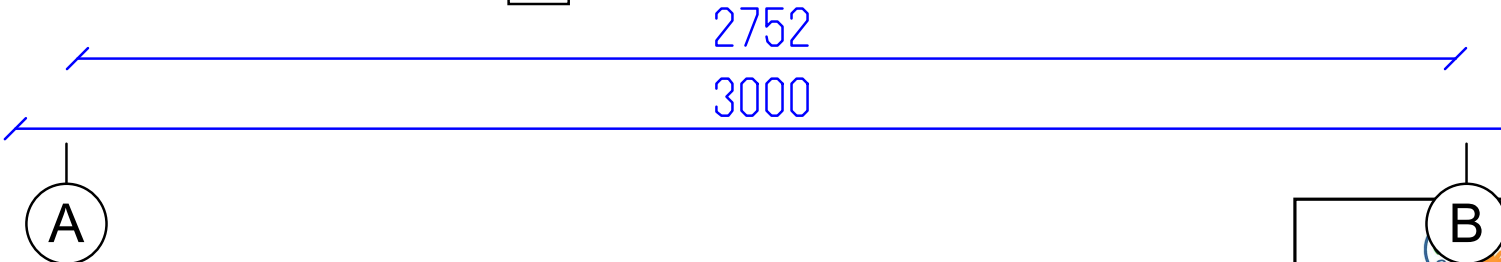

Livigno 44

Wall 2

Tikr.

Dare
AND

7
SHEET

8
OF

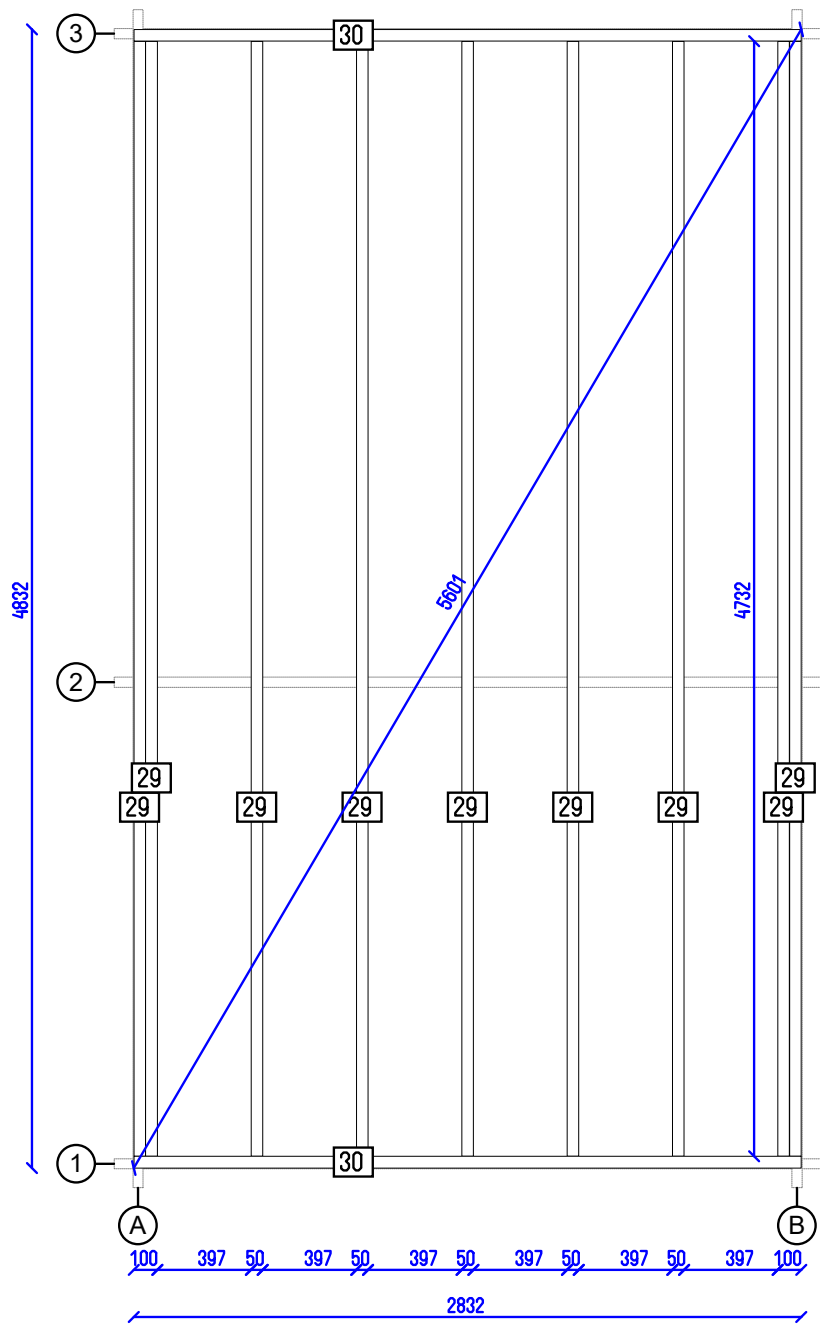

Livigno 44

Flr. bearers pl.

Tikr. ---

Dare AND

8 SHEET

8 OF