

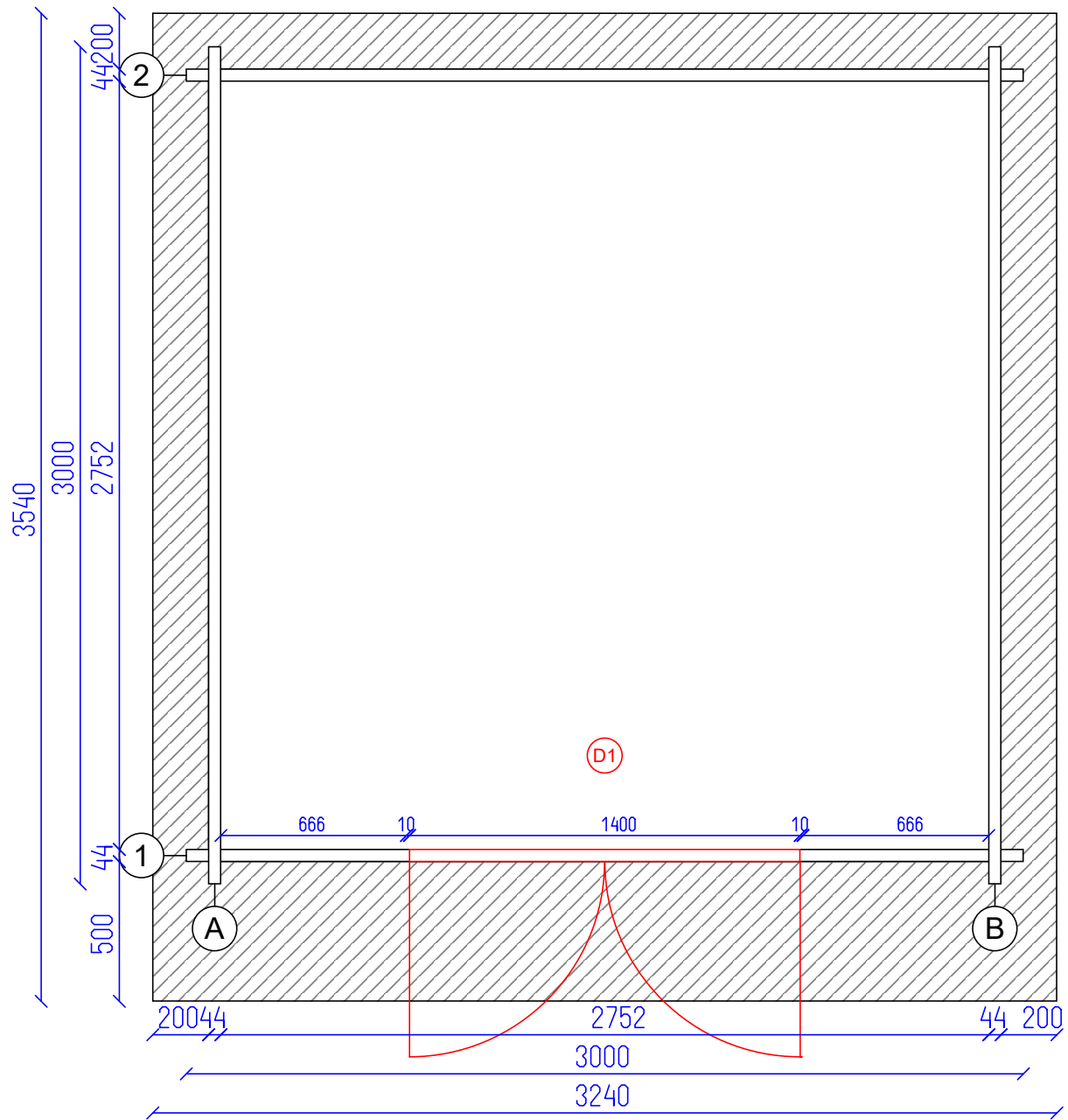

Cavalese 44 3x3

Tikr.	Dare	1	7
---	---	SHEET	OF



Cavalese 44 3x3

Ground plan

Tikr.

Dare

2
SHEET

7
OF

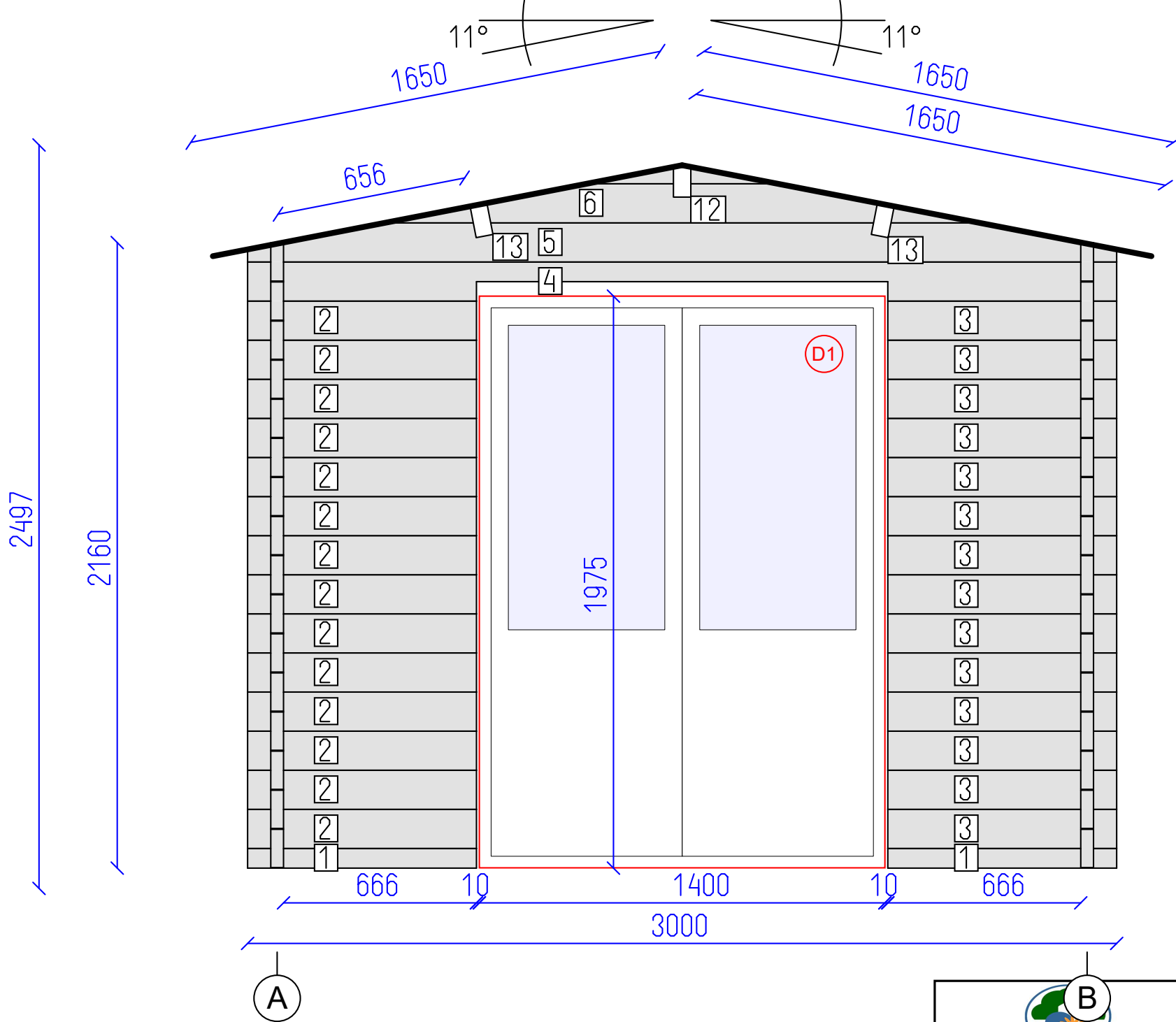

DETAILS

N	QTY
1	2
2	14
3	14
4	1
5	1
6	1
12	1
13	2

LIST OF ELEMENTS

- 1. Wall 68x44x790
 - 2. Wall 135x44x790
 - 3. Wall 135x44x790
 - 4. Wall 135x44x3000
 - 5. Wall 135x44x3000
 - 6. Wall 135x44x2054
 - 12. Roof beam 140x70x3540
 - 13. Roof beam 140x70x3540
- Total 5.67 m²

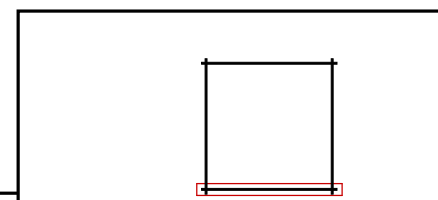

Cavalese 44 3x3



Wall 1

Tikr. ---

Dare ---

3 OF

7 OF

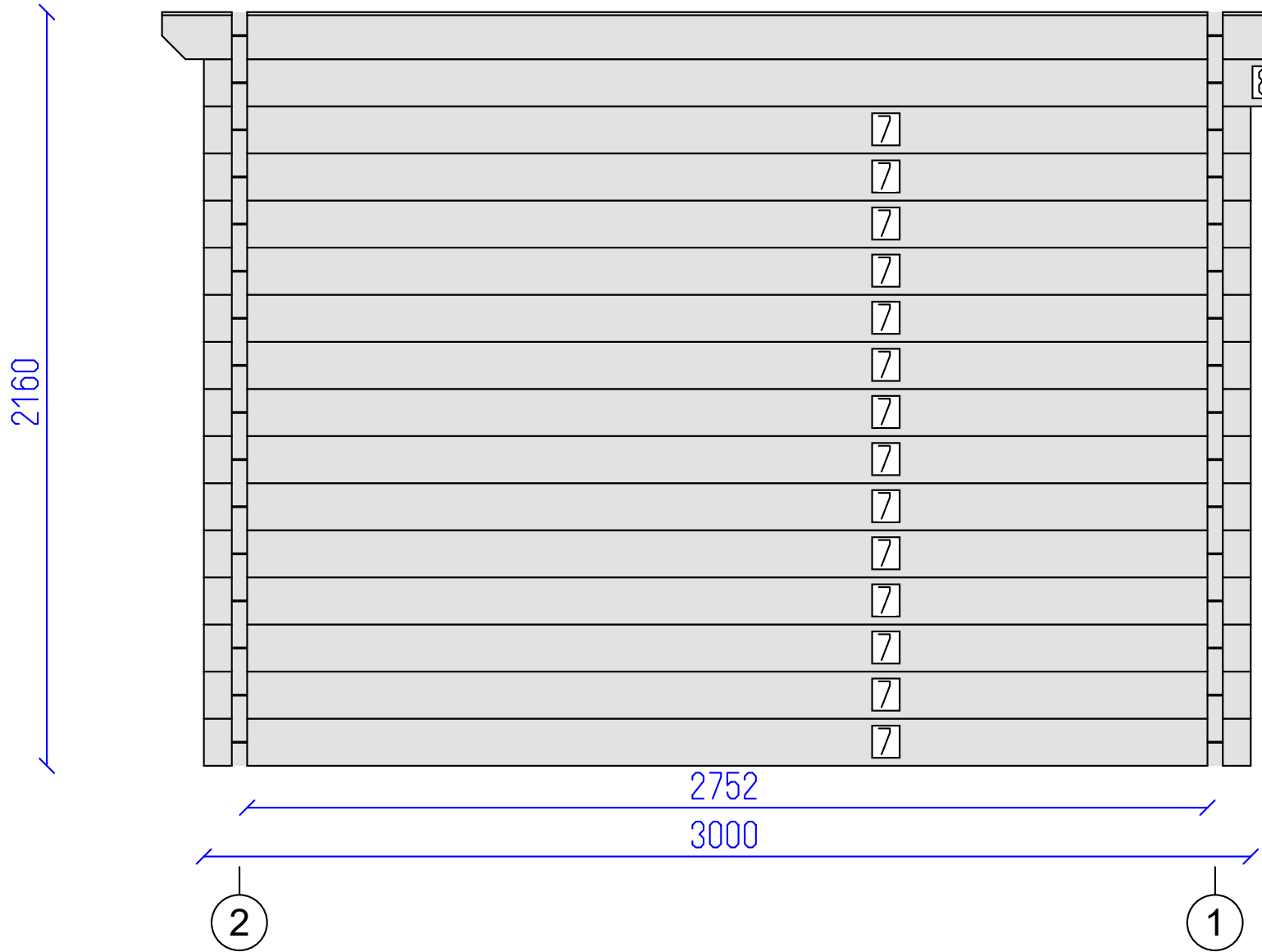

DETAILS

N	QTY
7	14
8	1
9	1

LIST OF ELEMENTS

7. Wall 135x44x3000
 8. Wall 135x44x3170
 9. Wall 135x44x3540
 Total 6.58 m²

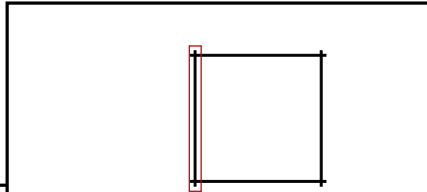

Cavalese 44 3x3

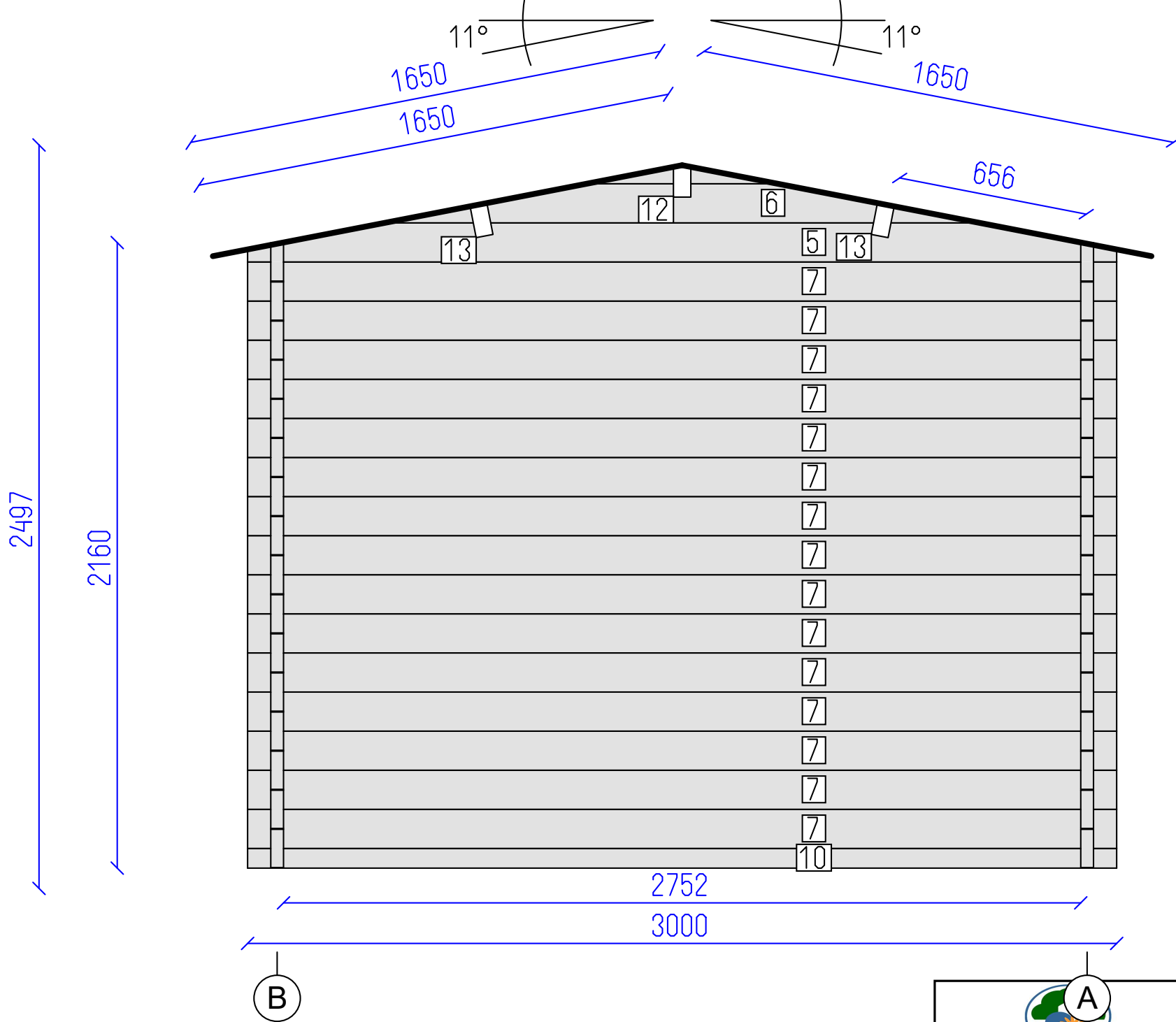

DETAILS

N	QTY
10	1
7	15
5	1
6	1
12	1
13	2

LIST OF ELEMENTS

- 10. Wall 68x44x3000
 - 7. Wall 135x44x3000
 - 5. Wall 135x44x3000
 - 6. Wall 135x44x2054
 - 12. Roof beam 140x70x3540
 - 13. Roof beam 140x70x3540
- Total 8.45 m²

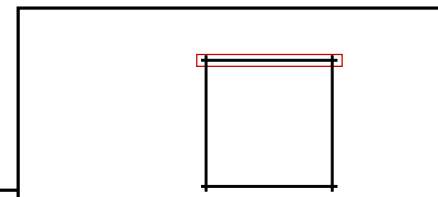

Cavalese 44 3x3



Wall 2

Tikr. ---

Dare ---

5

7

SHEET OF

DETAILS

N	QTY
7	14
8	1
11	1

LIST OF ELEMENTS

7. Wall 135x44x3000
 8. Wall 135x44x3170
 11. Wall 135x44x3540
 Total 6.58 m²

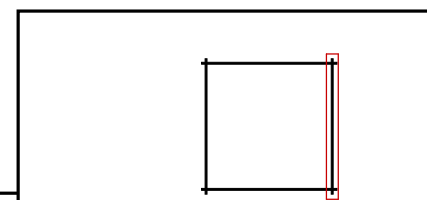
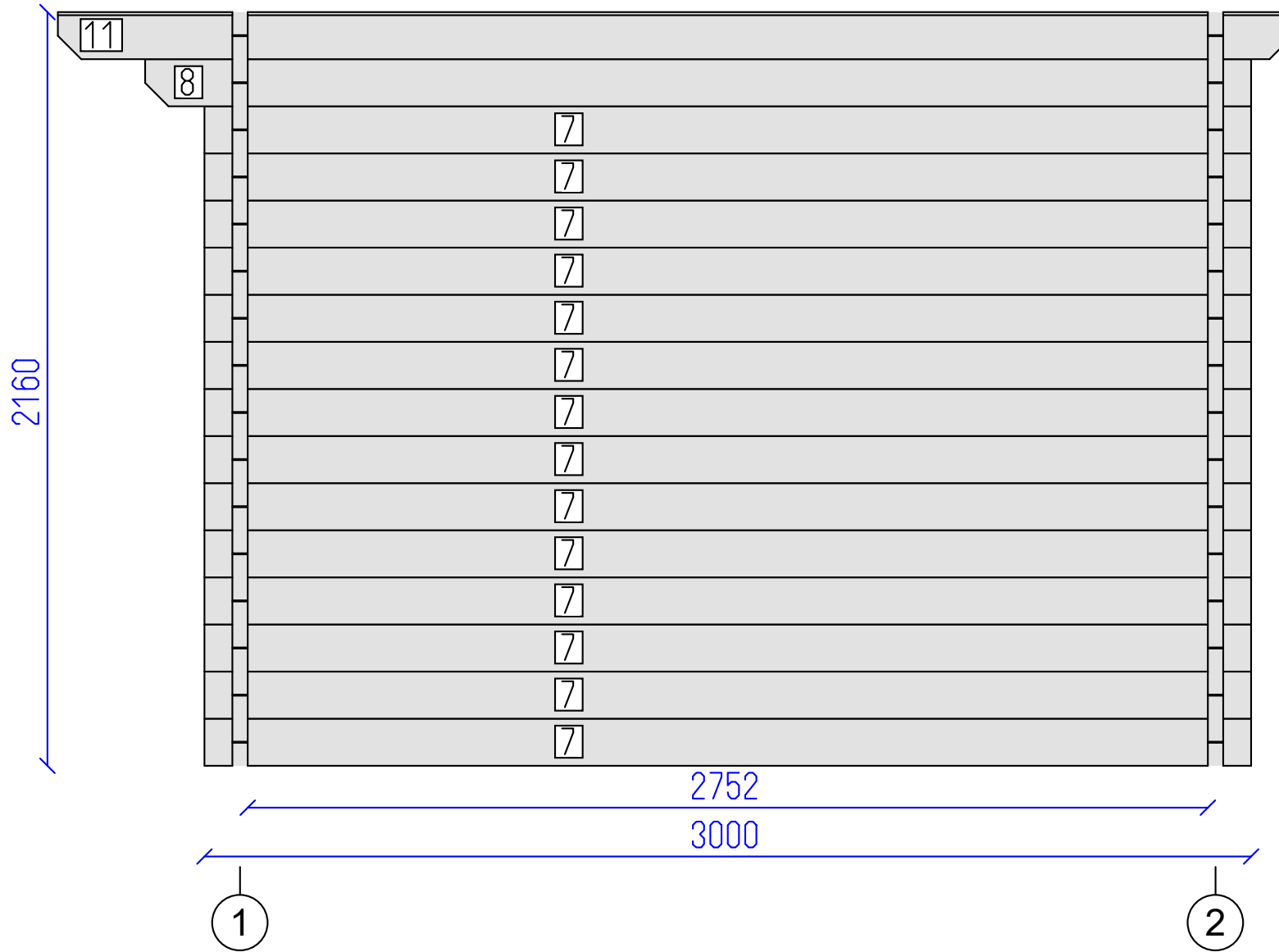

Cavalese 44 3x3



Wall B

Tikr. ---

Dare ---

6

7

SHEET OF

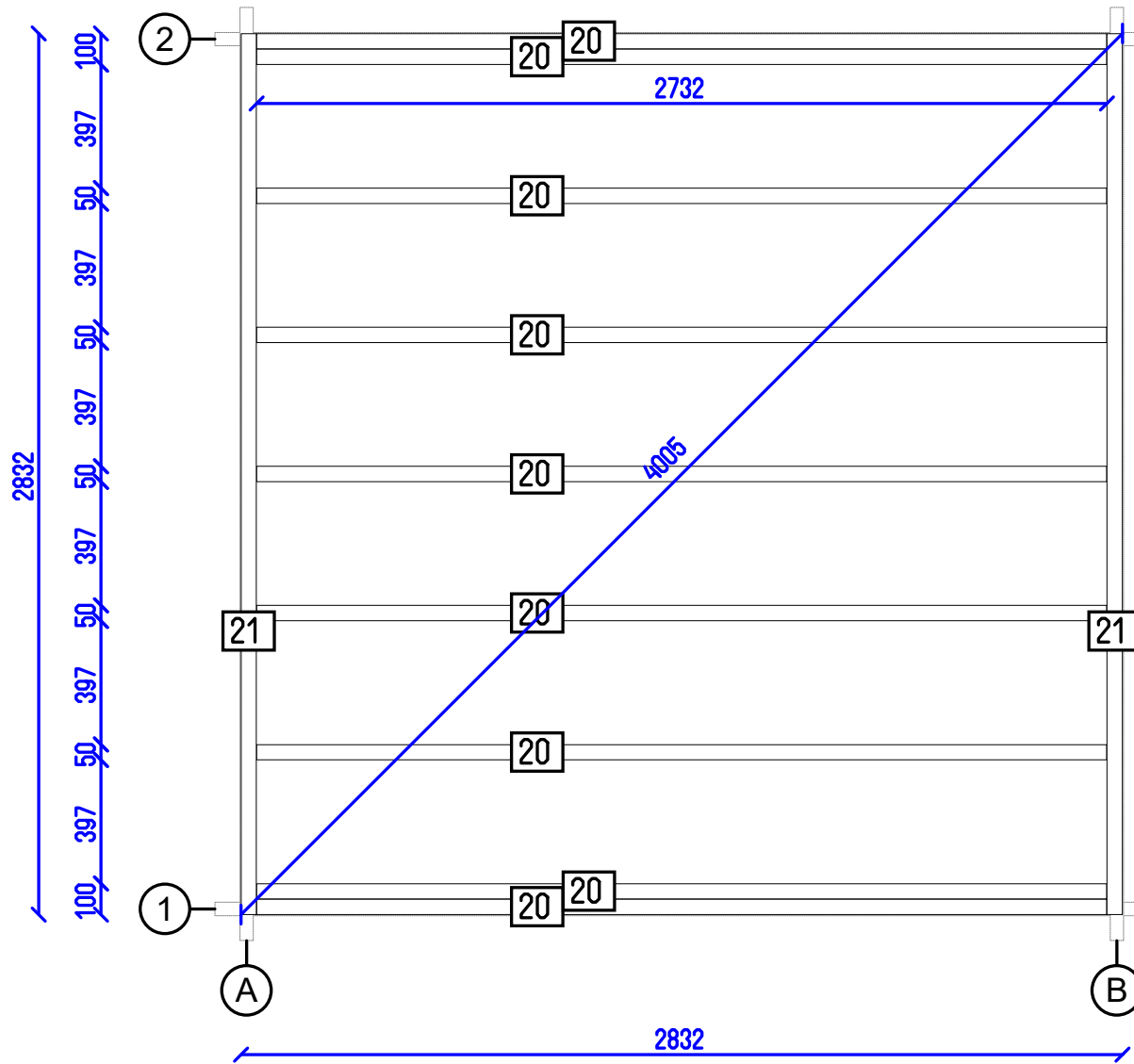

Cavalese 44 3x3

Flr. bearers pl.

Tikr.

Dare

7
SHEET

7
OF