

Belvedere Plus 5x6 44

Tikr.

Dare
AND

1

SHEET

10

OF

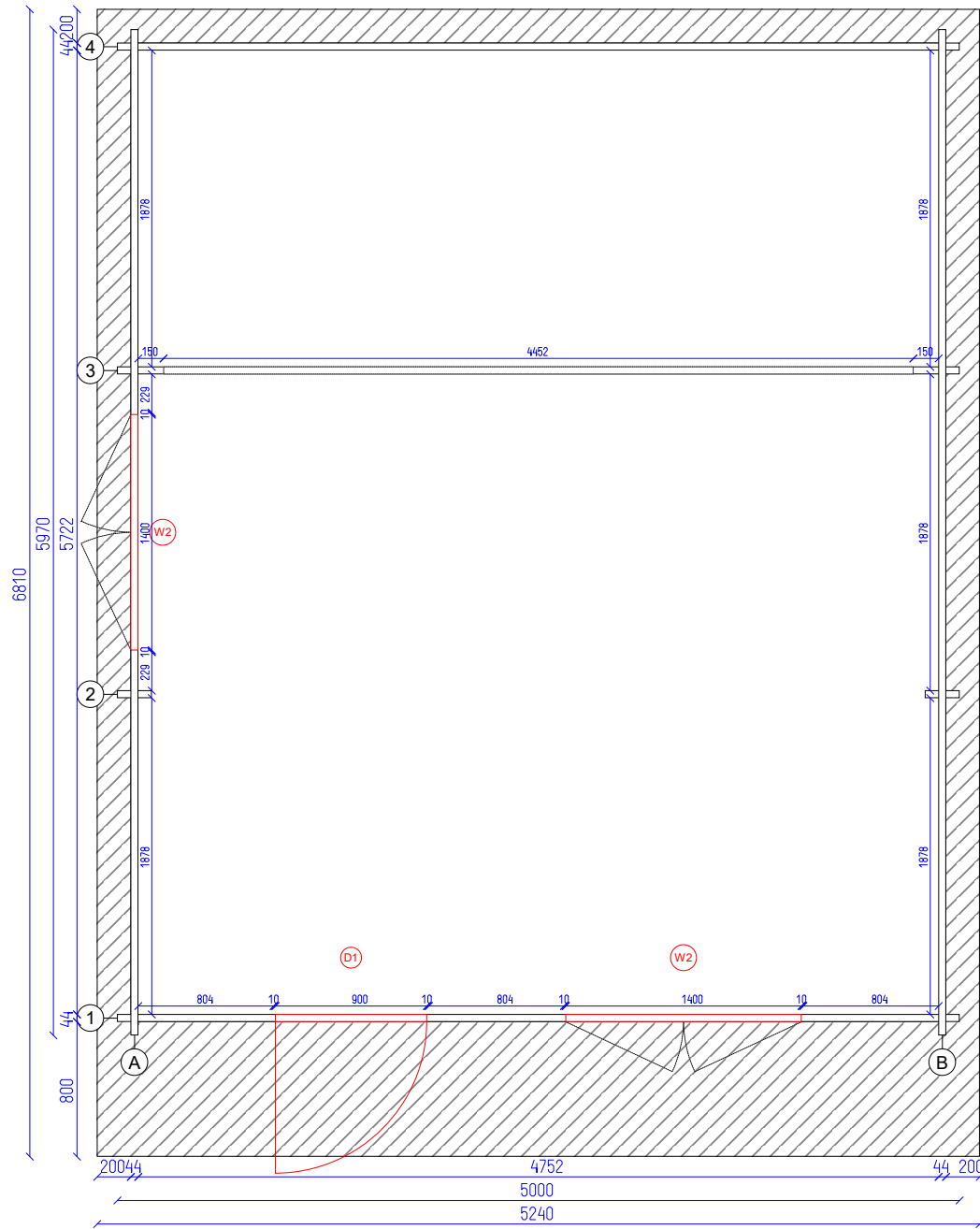

Belvedere Plus 5x6 44

Ground plan

Tikr.

Dare
AND

2
SHEET

10
OF

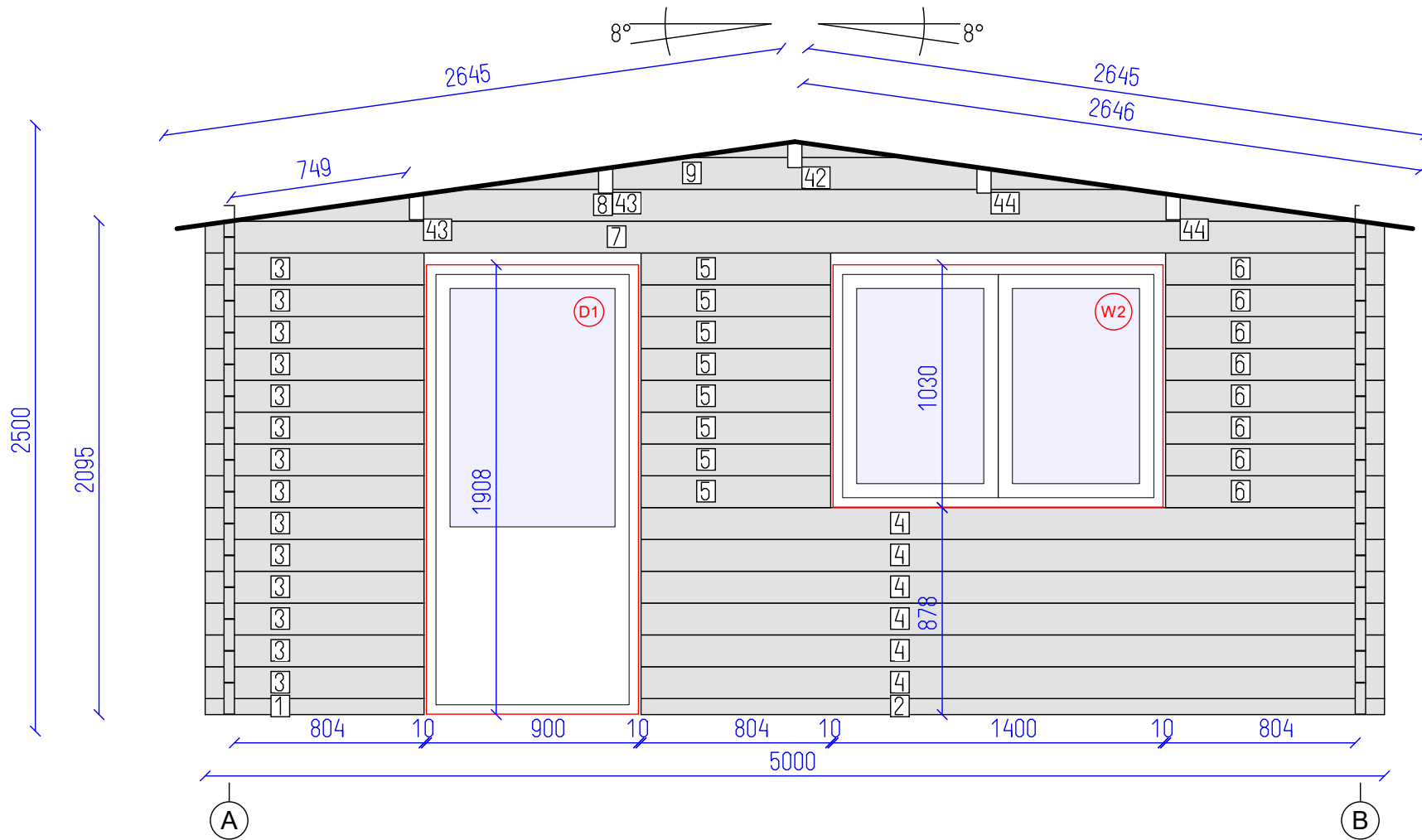

DETAILS

N	QTY
1	1
2	1
3	14
4	6
5	8
6	8
7	1
8	1
9	1
42	1
43	2
44	2

LIST OF ELEMENTS

1. Wall 68x44x928
 2. Wall 68x44x3152
 3. Wall 135x44x928
 4. Wall 135x44x3152
 5. Wall 135x44x804
 6. Wall 135x44x928
 7. Wall 135x44x5000
 8. Wall 135x44x4786
 9. Wall 135x44x2872
 42. Roof beam 140x70x4944
 43. Roof beam 140x70x4944
 44. Roof beam 140x70x4944
- Total 11.62 m²

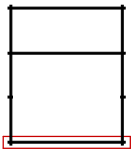

Belvedere Plus 5x6 44



Wall 1

Tikr.

Dare
AND

3

10

SHEET OF

DETAILS

N	QTY
10	6
11	1
12	5
13	7
14	1
15	1
16	1
17	1
18	1
19	1

LIST OF ELEMENTS

- 10. Wall 135x44x5970
 - 11. Wall 135x44x5970
 - 12. Wall 135x44x2275
 - 13. Wall 135x44x2275
 - 14. Wall 135x44x2462
 - 15. Wall 135x44x2728
 - 16. Wall 135x44x2744
 - 17. Wall 135x44x4066
 - 18. Wall 70x44x2744
 - 19. Wall 70x44x4066
- Total 11.42 m²

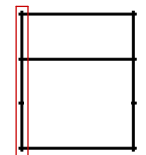
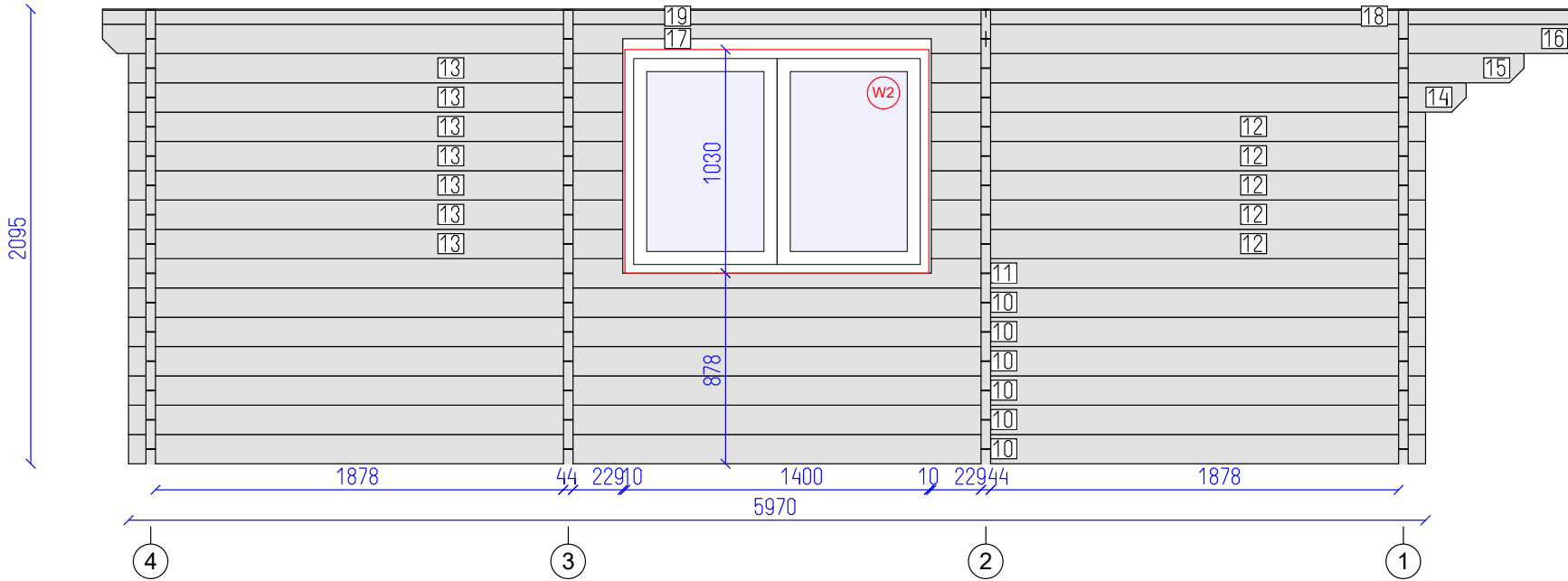

Belvedere Plus 5x6 44



Wall A

Tikr. ---

Dare AND

4

10 OF SHEET

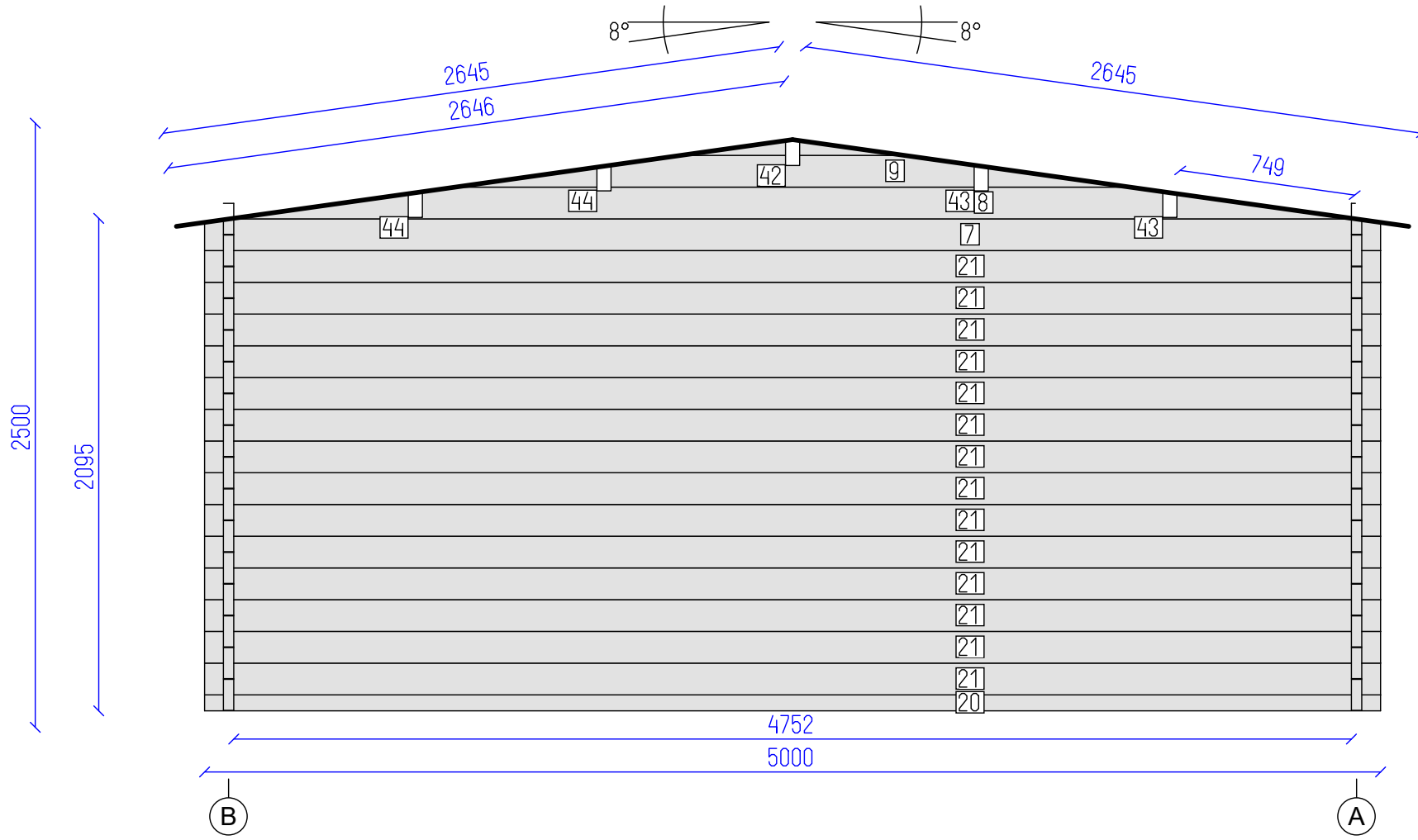

DETAILS

N	QTY
20	1
21	14
7	1
8	1
9	1
42	1
43	2
44	2

LIST OF ELEMENTS

- 20. Wall 68x44x5000
 - 21. Wall 135x44x5000
 - 7. Wall 135x44x5000
 - 8. Wall 135x44x4786
 - 9. Wall 135x44x2872
 - 42. Roof beam 140x70x4944
 - 43. Roof beam 140x70x4944
 - 44. Roof beam 140x70x4944
- Total 14.96 m²

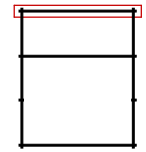

Belvedere Plus 5x6 44



Wall 4

Tikr.

Dare
AND

5
SHEET

10
OF

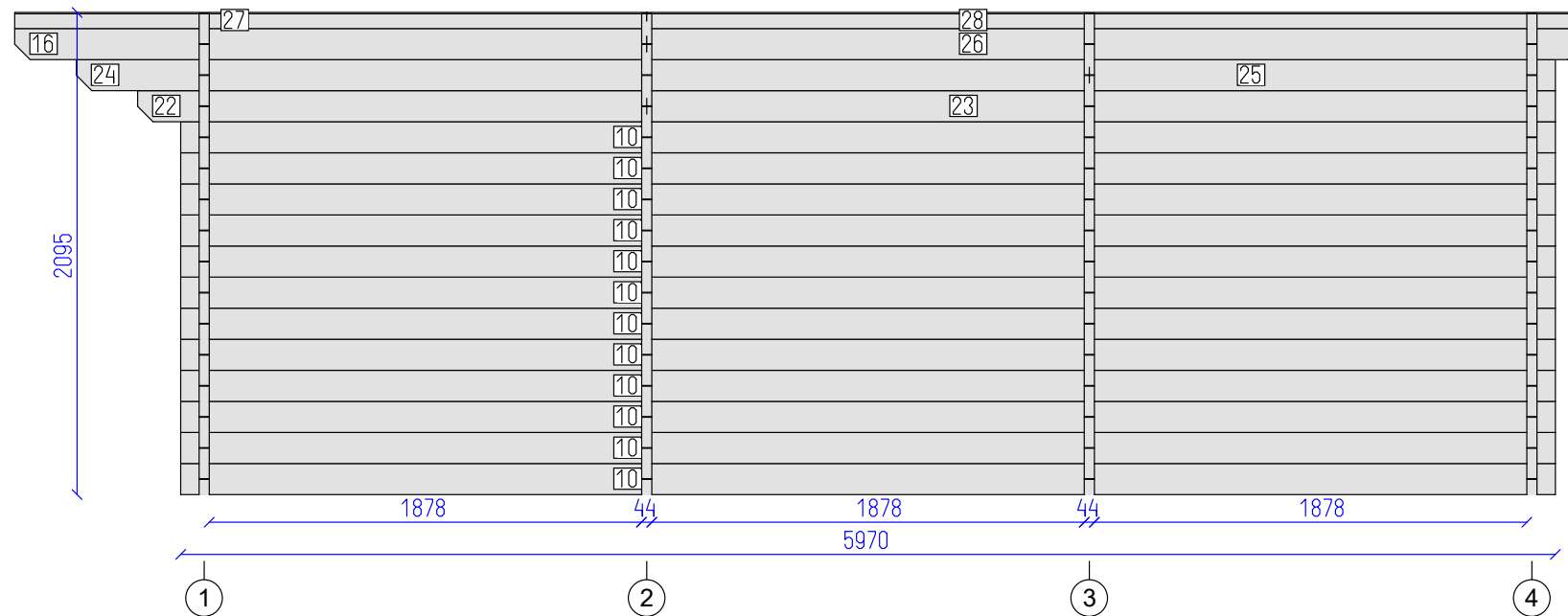

DETAILS

N	QTY
10	12
22	1
23	1
24	1
25	1
16	1
26	1
27	1
28	1

LIST OF ELEMENTS

- 10. Wall 135x44x5970
 - 22. Wall 135x44x2211
 - 23. Wall 135x44x3946
 - 24. Wall 135x44x4399
 - 25. Wall 135x44x2024
 - 16. Wall 135x44x2744
 - 26. Wall 135x44x4066
 - 27. Wall 70x44x2744
 - 28. Wall 70x44x4066
- Total 12.77 m²

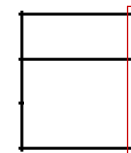

Belvedere Plus 5x6 44



Wall B

Tikr. ---

Dare AND

6 SHEET

10 OF

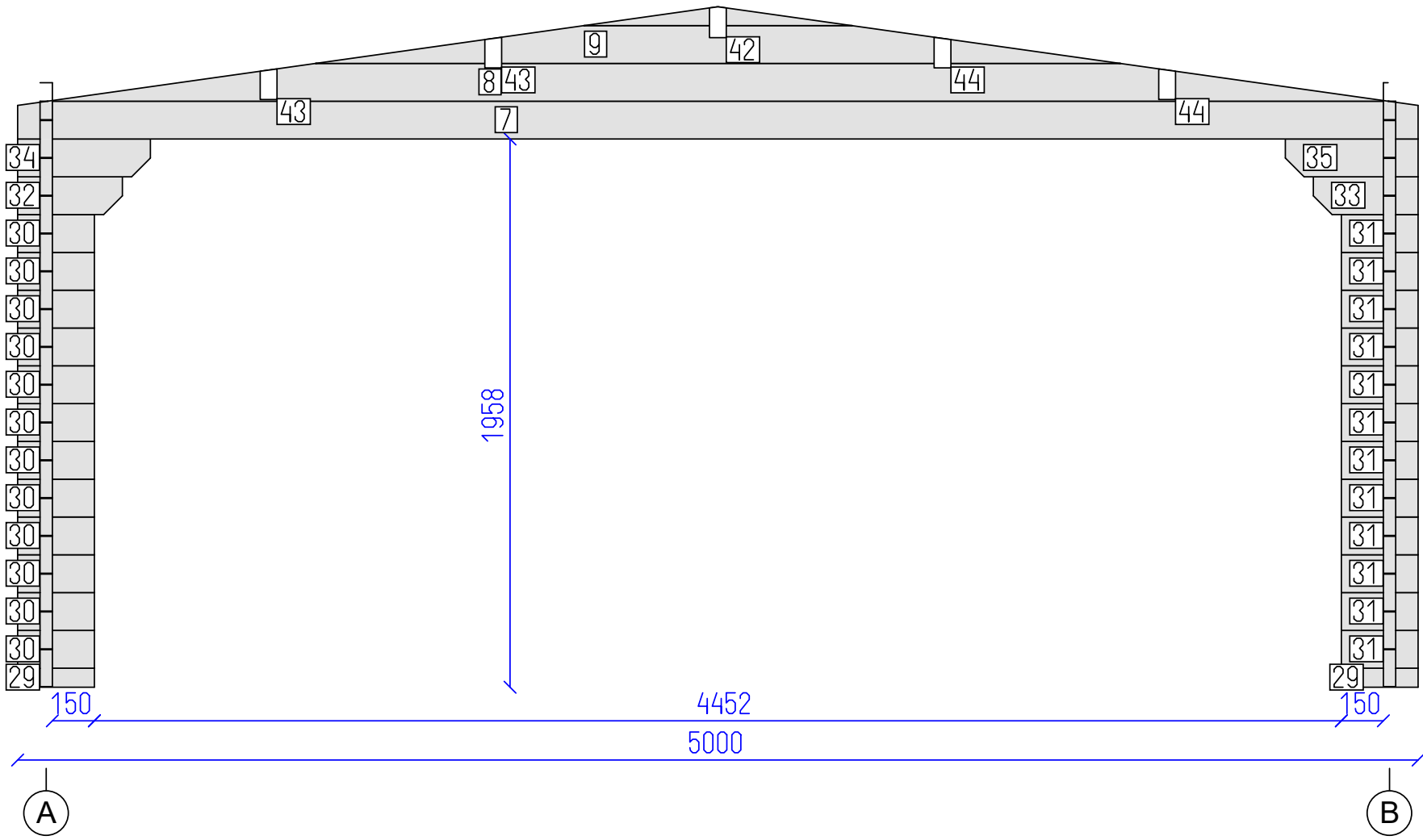

DETAILS

N	QTY
29	2
30	12
31	12
32	1
33	1
34	1
35	1
7	1
8	1
9	1
42	1
43	2
44	2

LIST OF ELEMENTS

- 29. Wall 68x44x274
- 30. Wall 135x44x274
- 31. Wall 135x44x274
- 32. Wall 135x44x374
- 33. Wall 135x44x374
- 34. Wall 135x44x474
- 35. Wall 135x44x474
- 7. Wall 135x44x5000
- 8. Wall 135x44x4786
- 9. Wall 135x44x2872
- 42. Roof beam 140x70x4944
- 43. Roof beam 140x70x4944
- 44. Roof beam 140x70x4944

Total 6.32 m²

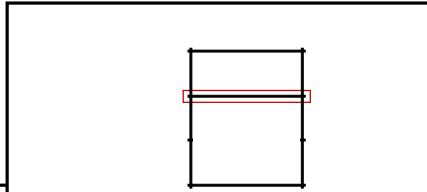

Belvedere Plus 5x6 44

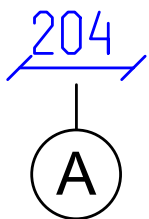
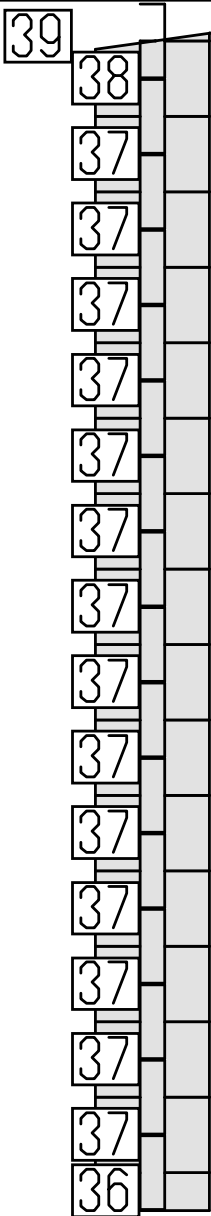

DETAILS

N	QTY
36	1
37	14
38	1
39	1

LIST OF ELEMENTS

36. Wall 68x44x204
 37. Wall 135x44x204
 38. Wall 135x44x204
 39. Wall 14x44x97
 Total 0.43 m²

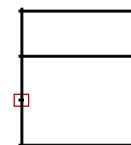

Belvedere Plus 5x6 44



Wall 2

Tikr.

Dare
AND

8

10
OF

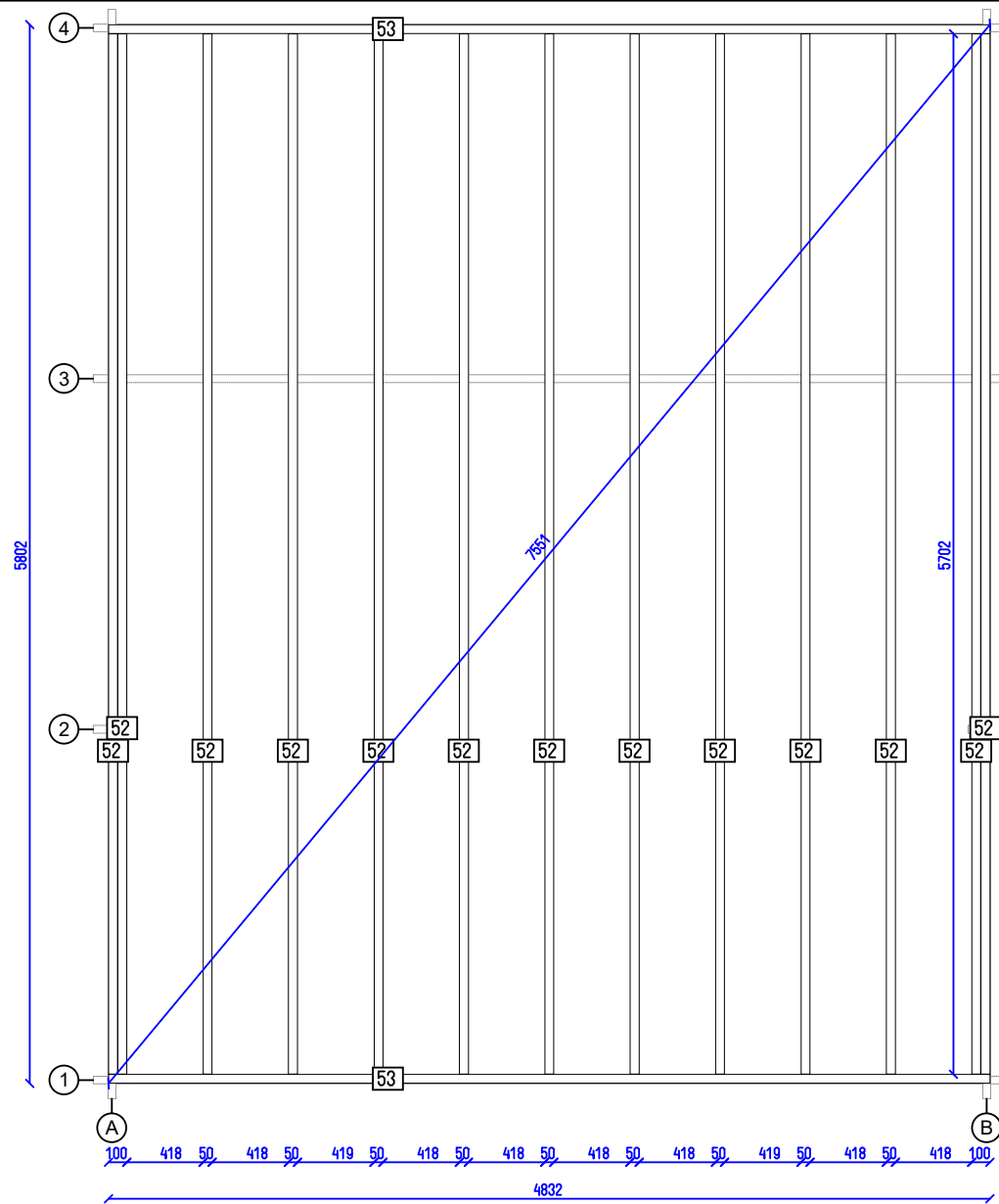

Belvedere Plus 5x6 44

Flr. bearers pl.

Tikr. ---

Dare AND

10 SHEET

10 OF