

A parts list of the position



| Highlander 4x3 LTH | | | | |
|--------------------|----------------------------------|-------------------|-----|-------|
| Position | Name | L Length mm | Q | M2 |
| 003. | Foundation treated bearer | 1889 | 1 | |
| 003.a | Foundation treated bearer | 2813 | 1 | |
| 003.b | Foundation treated bearer | 3719 | 7 | |
| 003.c | Foundation treated bearer | 1949 | 3 | |
| 003.d | Foundation treated bearer | 924 | 1 | |
| 003.e | Foundation treated bearer | 1676 | 4 | |
| 003.f | Foundation treated bearer | 924 | 1 | |
| 007. | Terrace floor board | 881 | | 1,69 |
| 008. | Floor board | 1793 | | 9,50 |
| 008.a | Floor board | 2717 | | |
| 009. | trims for flooring | 1843 | 1 | |
| 009.a | trims for flooring | 1884 | 2 | |
| 009.b | trims for flooring | 1384 | 2 | |
| 009.c | trims for flooring | 1997 | 1 | |
| 009.d | trims for flooring | 921 | 2 | |
| 009.e | trims for flooring | 1767 | 2 | |
| 010. | Strip (for inside roof) | 29800 | 1 | |
| 017. | Various wall log 44x135 | 239312 | 1 | |
| 037. | Roof board | 1605 | | 14,19 |
| 039. | Fascia board | 1625 | 4 | |
| 039.a | Fascia board strip | 1635 | 4 | |
| 039.b | Roof strip | 2185 | 4 | |
| 043. | Strip | 1860 | 1 | |
| 044. | Double outside door 1295x1860mm | - | 1 | |
| 045. | Single window 700x910mm | - | 2 | |
| 046. | Double door strip (horizontal) | 1395 | 2 | |
| 046.a | Double door strip (vertical) | 1830 | 4 | |
| 046.b | Single window strip (horizontal) | 800 | 8 | |
| 046.c | Single window strip (vertical) | 880 | 8 | |
| 058. | Rhombus | 135 | 4 | |
| 060. | Screw for walls 6x180 | - | 122 | |
| 060.a | Screw set | - | 1 | |
| 060.b | Screw 5x80 | - | 42 | |
| 070. | Door/window hardware | - | 1 | |
| 070.a | Door/window hardware | - | 1 | |
| 070.b | Door/window hardware | - | 1 | |
| 070.c | Screw | - | 8 | |
| 070.d | Door/window hardware | - | 4 | |

I. Architectural drawings

Alpina plus 4x3 LTH (44)

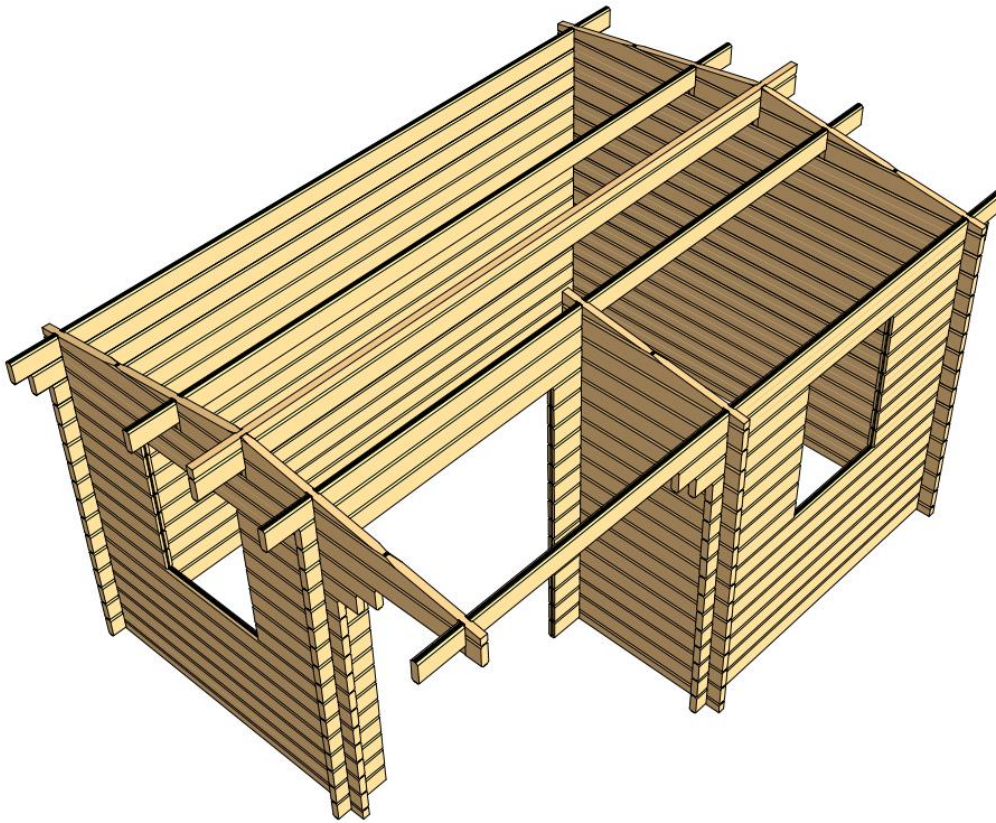

I.1. Foundation plan dimensions:

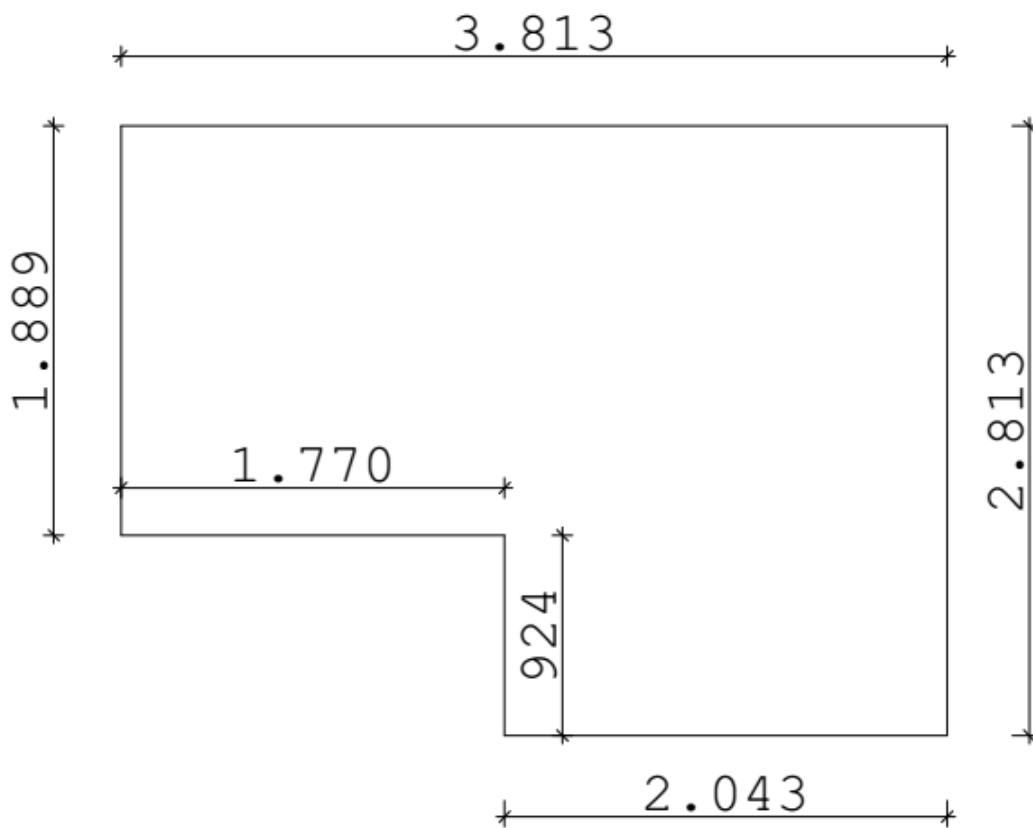



I.2. Building plan:

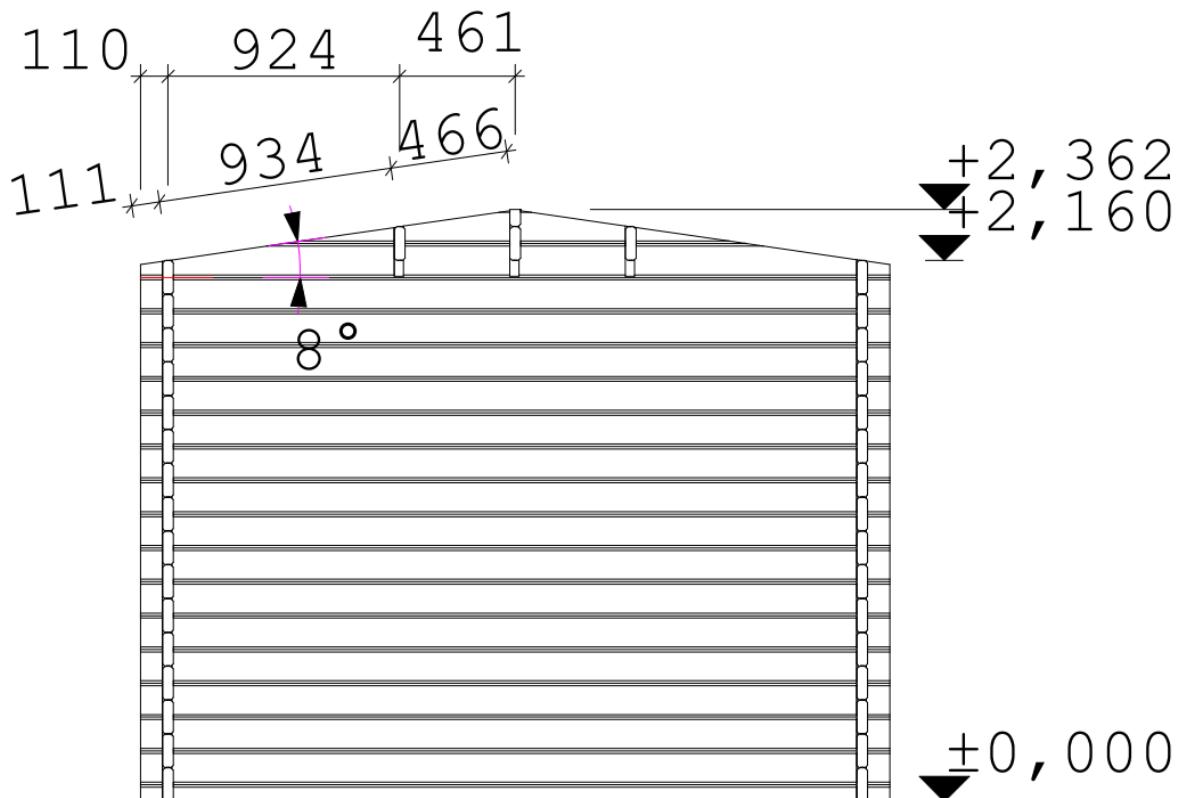
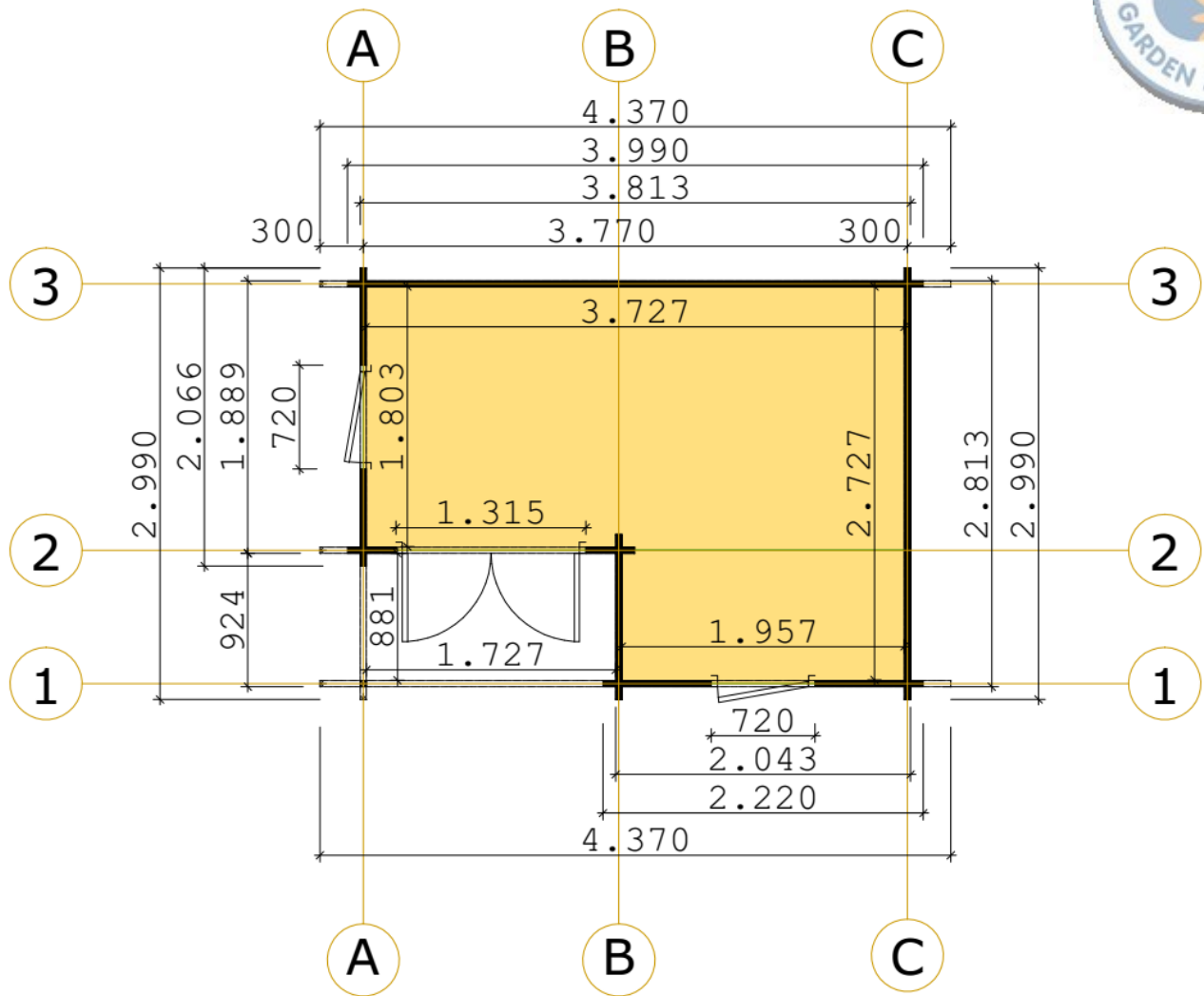

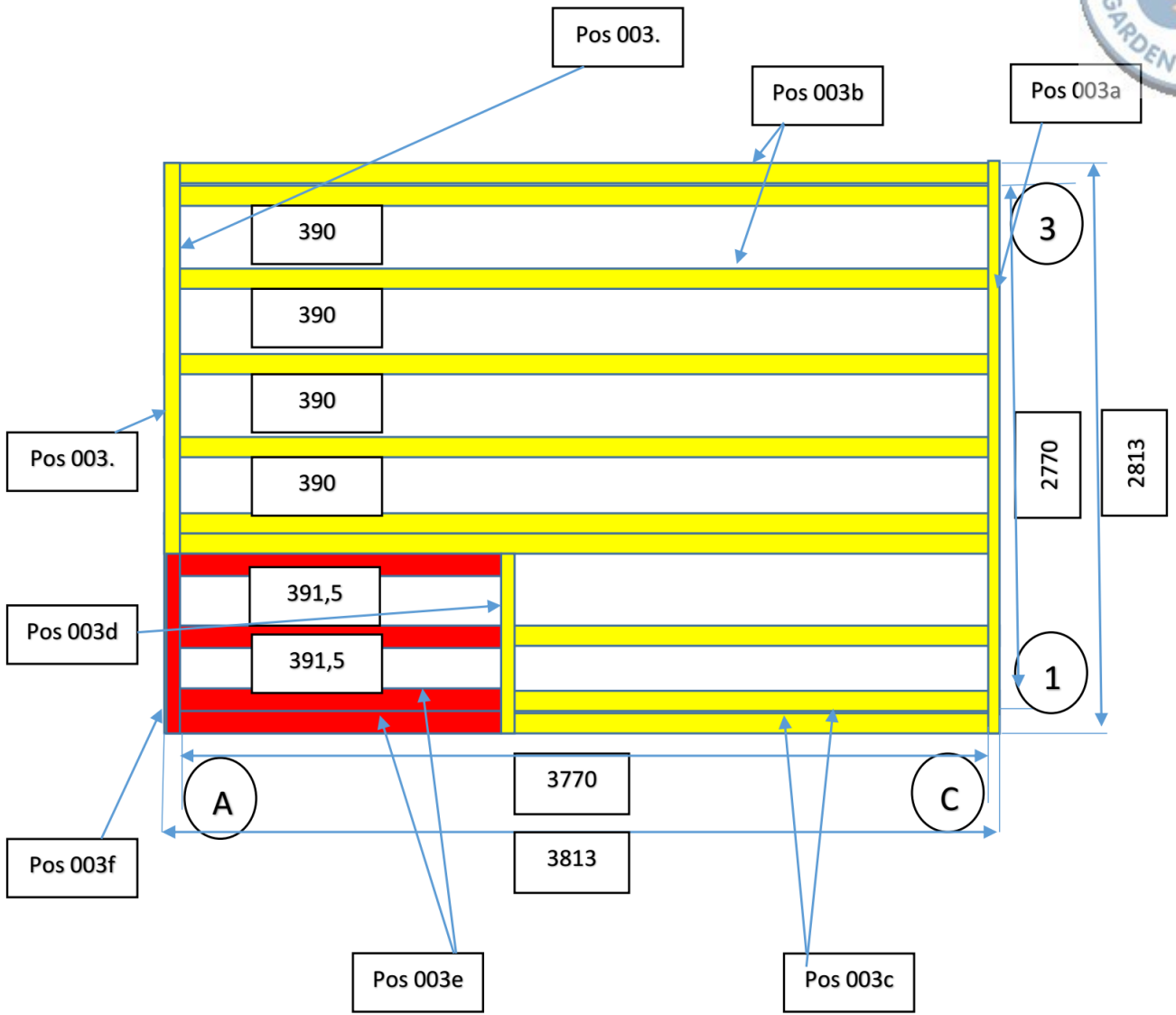

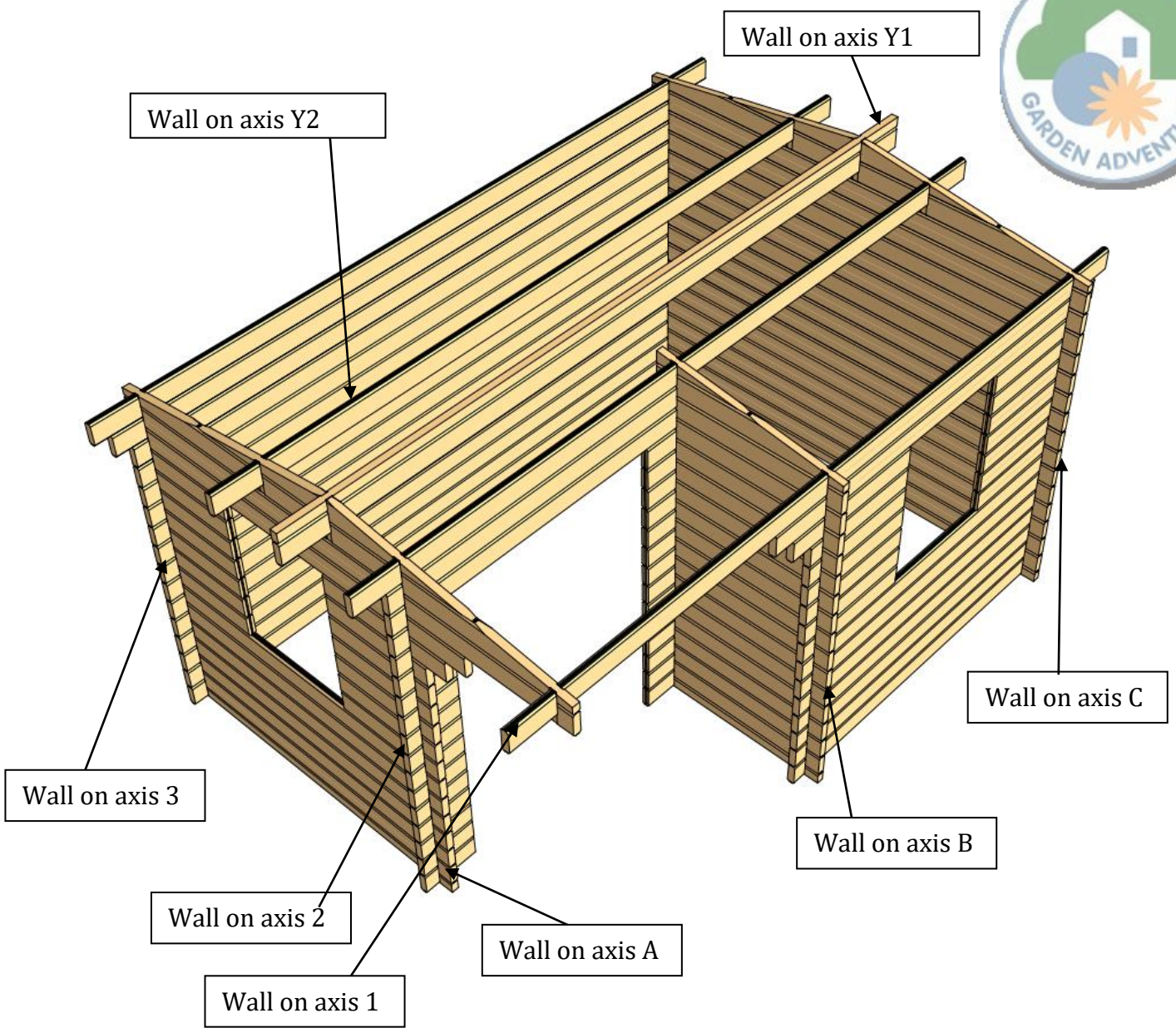



We recommend 20 screw to this wall.

Wall on axis 1

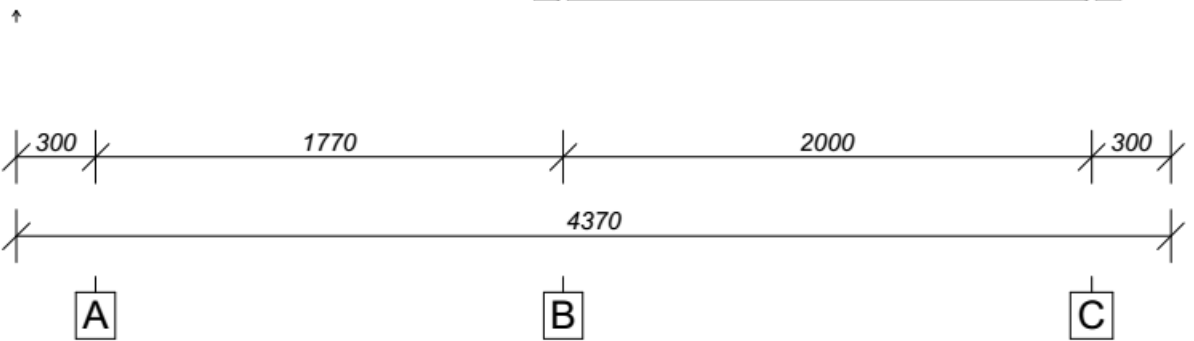
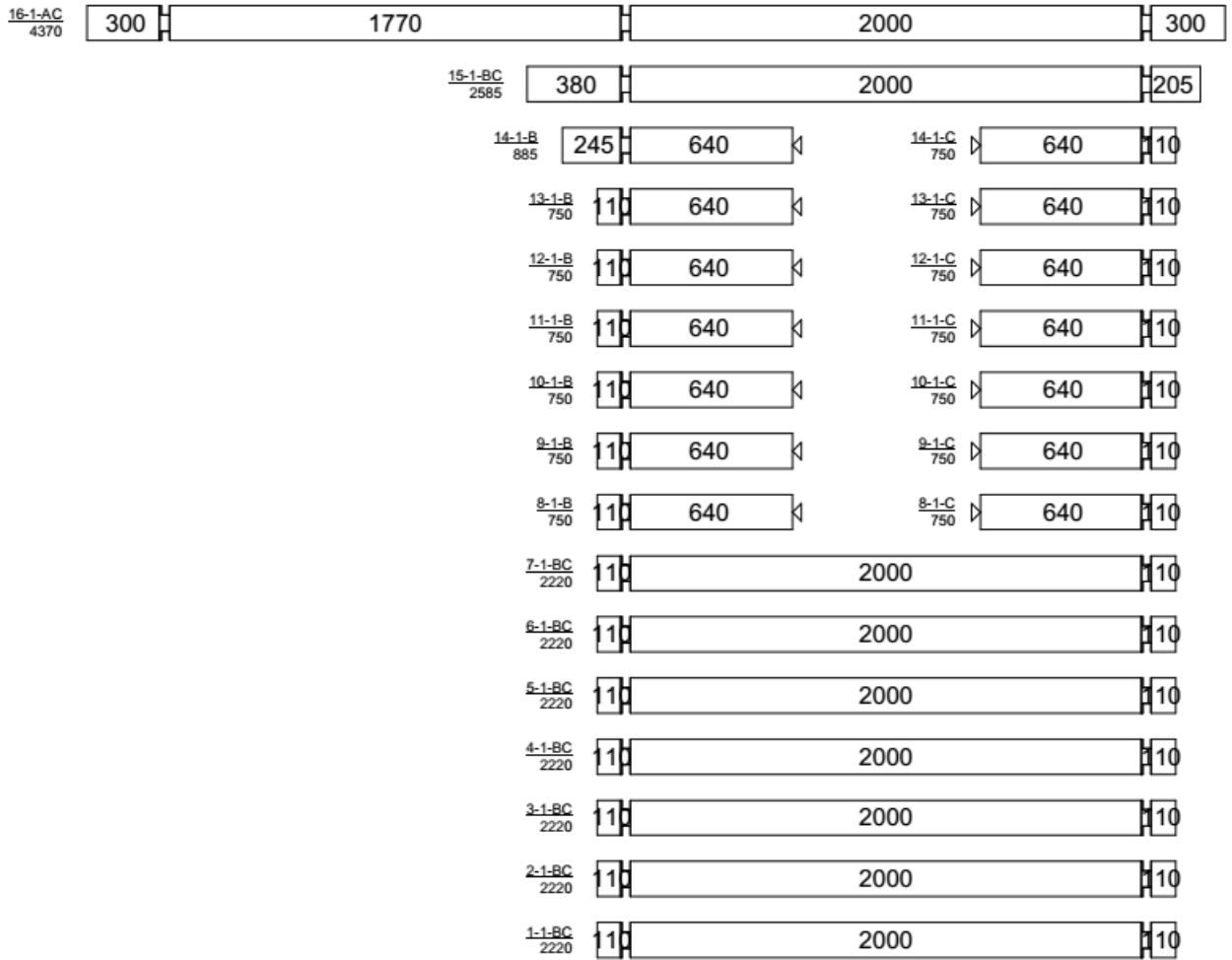



We recommend 19 screws to this wall.

Wall on axis 2

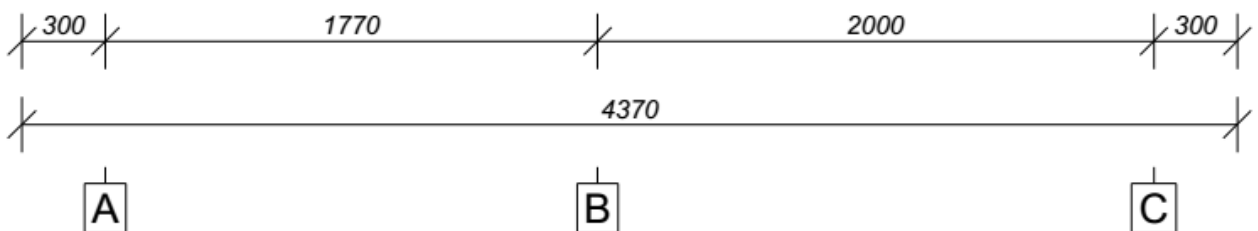
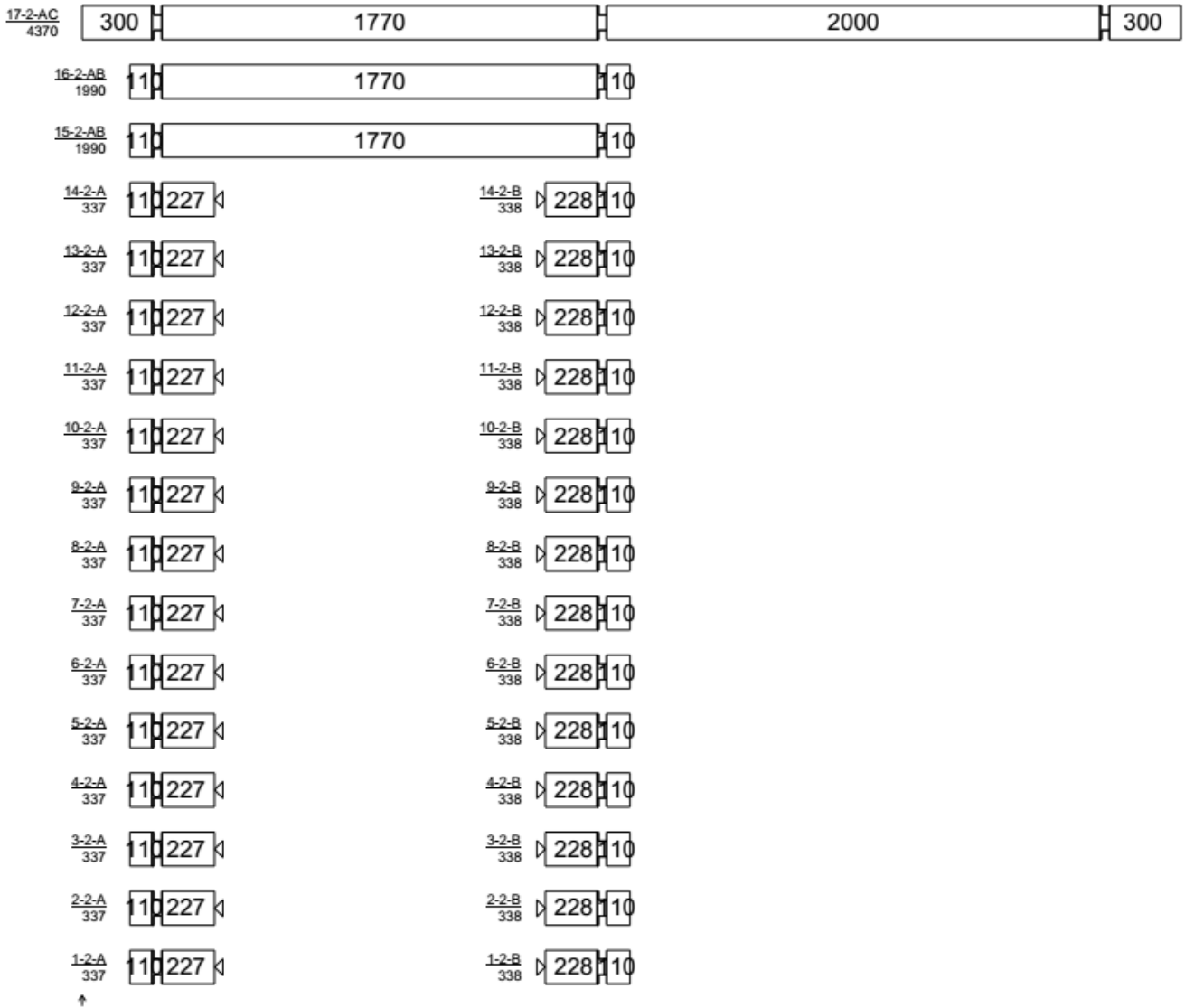



We recommend 23 screws to this wall.

Wall on axis 3

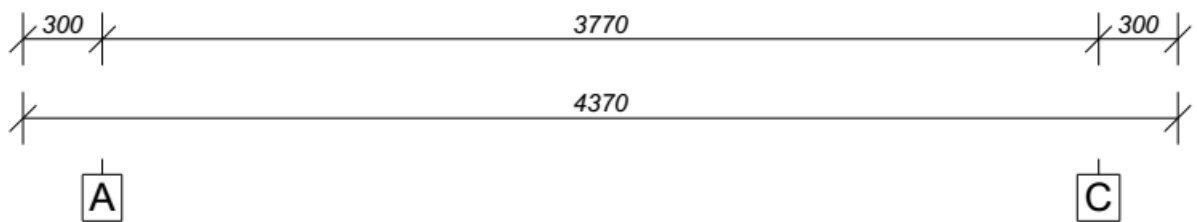
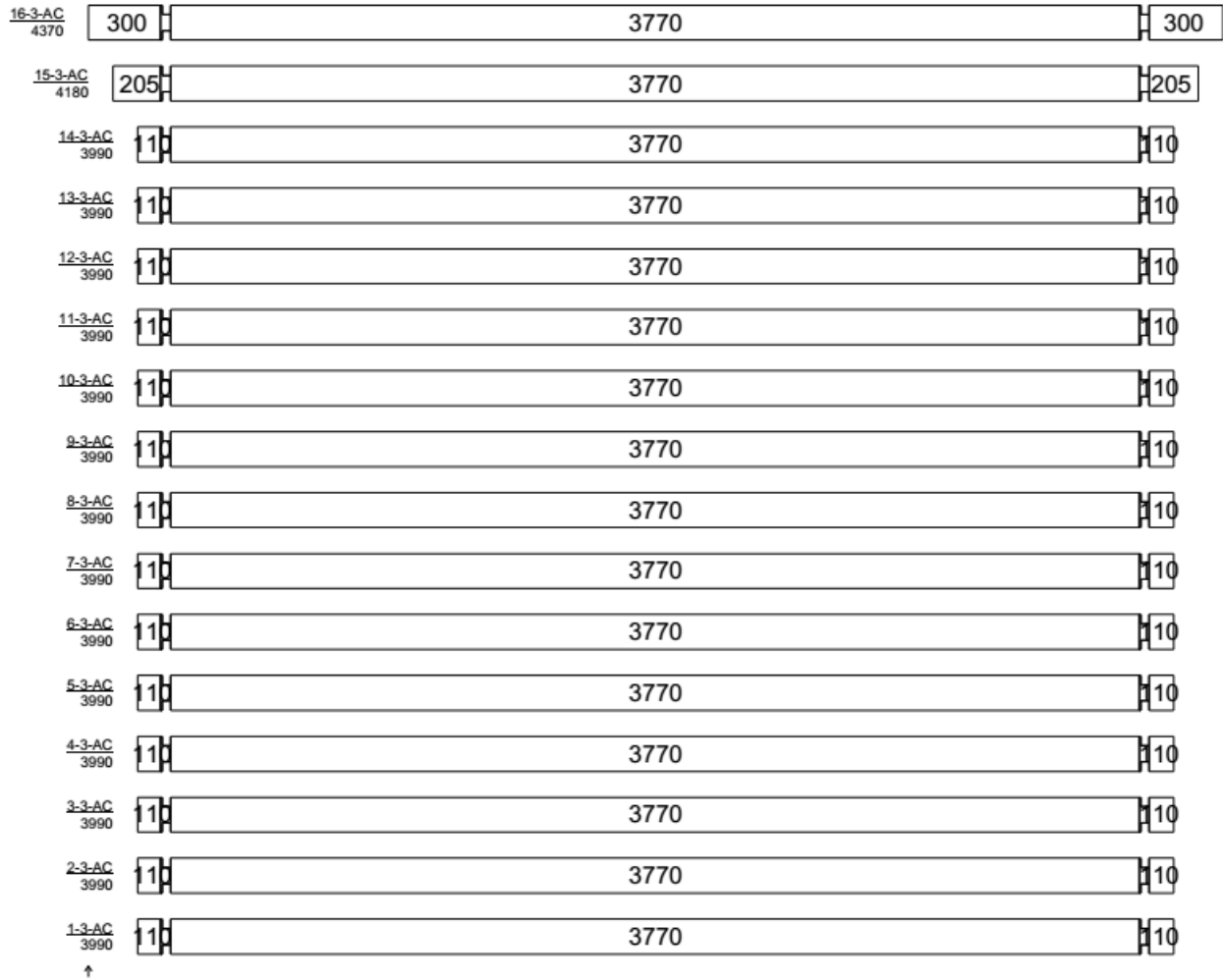

We recommend
23 screw to this
wall.



Wall on axis A

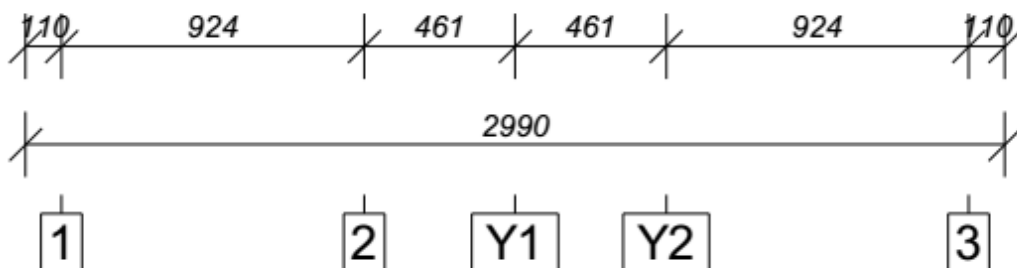
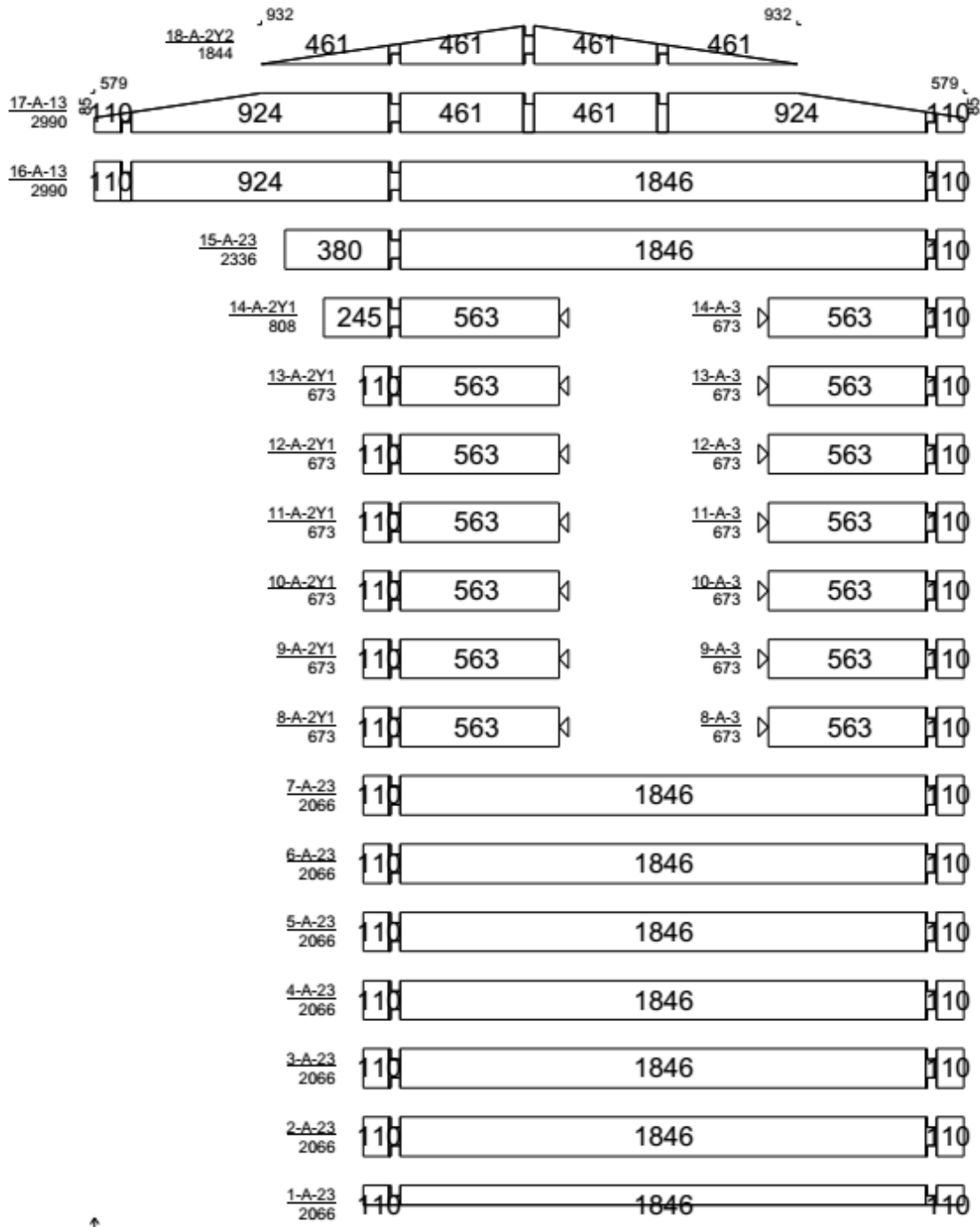



We recommend 9 screw to this wall.

Wall on axis B

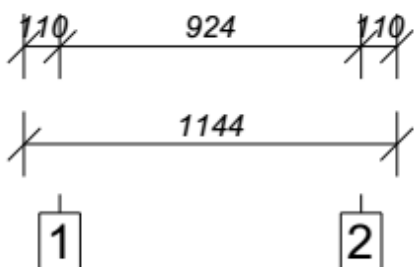
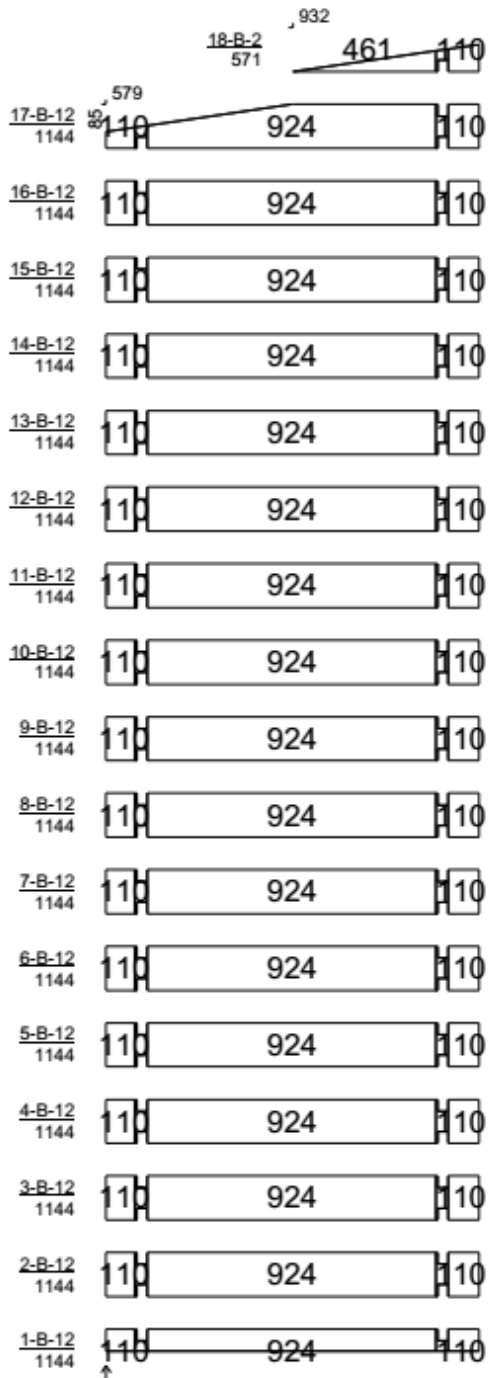

We recommend
26 screw to this
wall.



Wall on axis C

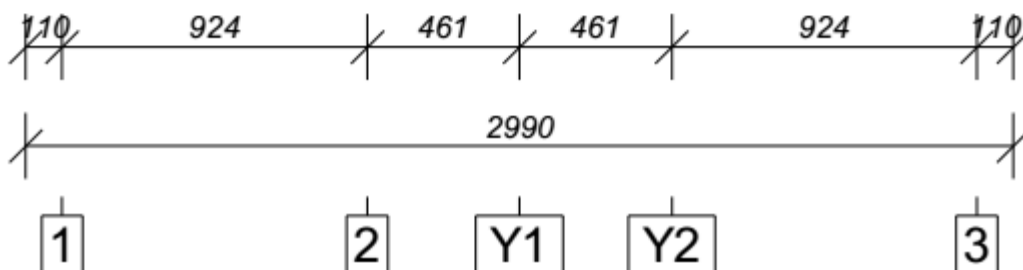
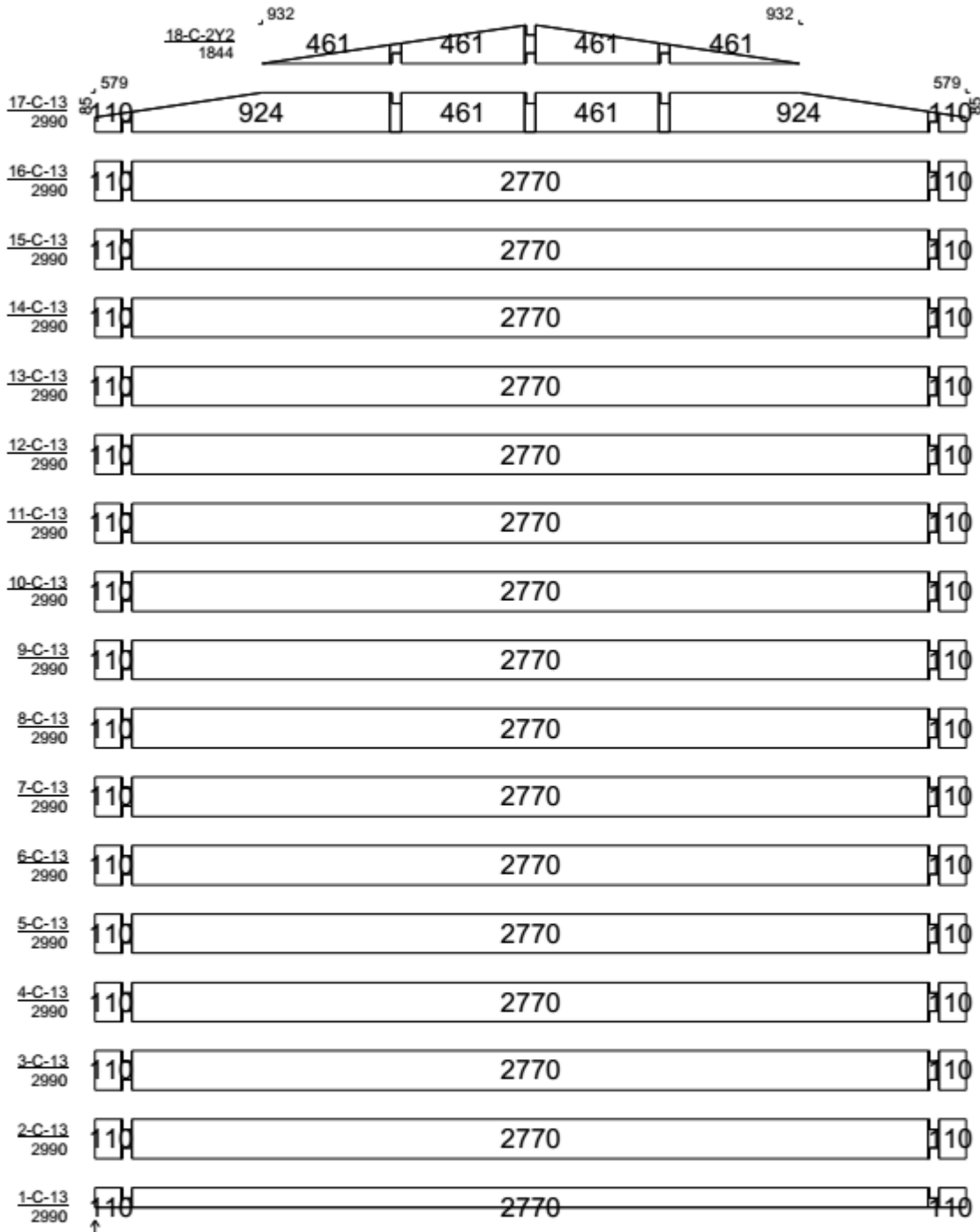

We recommend 2
screw to this wall.

Wall on axis Y1

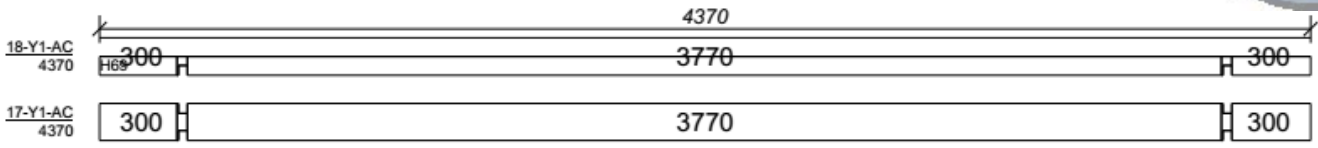

↑

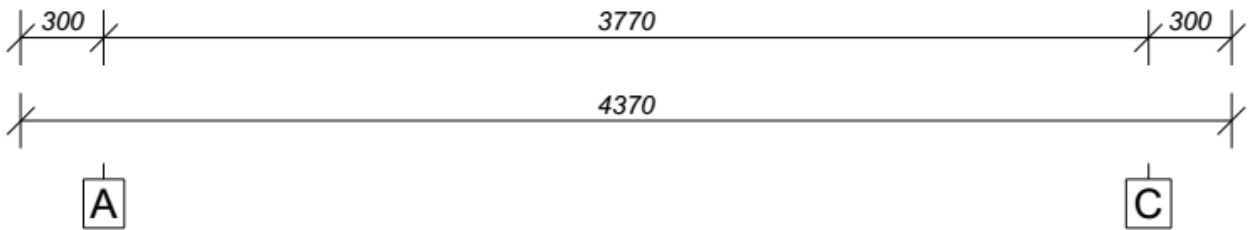



Wall on axis Y2

17-Y2-AC
4370

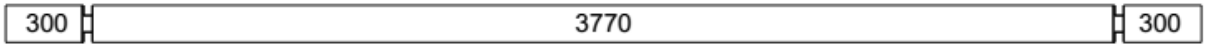

↑

