

Wood characteristics

Wood has a number of specific characteristics, which are natural and inherent to it. The biggest practical moment is, that the wood has its specific colour and density, also the effect of humidity result.

In longitudinal cut most of the wood has a nice, decorative and often very appreciable cut-out which is called texture.

Wood has a specific scent. The scent is given by attars, resins and fermented substances. New-mown wood gives a better scent.

A very important attribute of the wood is to store and easily return the water.

The bad attribute is to bloat and dry out. When wood is drying, it shrinks its linear measurements and volume decrease. When the wood absorbs humidity its linear measurements and volumes increase.

Downsides of the wood are that it chaps and warps. When wood dries, humidity firstly evaporates from the surface, outer layers and only after from deeper inside layers. That is why, when the outer layers start to shrink, the inside layers, due to bigger wetness, oppose to drawing. Firstly the surface is chapping, next the inside. When wood dries it can have longitudinal or cross warp. Longitudinal: When dried straight balk bends, flat plank twists and gets the form of the propeller. Cross: When the form of woods' cross-section is changing, quadratic balk becomes the balk with rectangular or rhomb cross-section, flat plank becomes hunched.

Wood has a number of specific technological characteristics. It easily splits along the fibre, nicely holding metal fastenings, it can flex easily, is durable to depreciation. Screws hold in the wood extremely well. Screws have a much better grip with the wood than the nails, and they do not cut the strings.

Peculiarity of the wood (taints): branchy wood, cracks, subnormal structure, infractions made by fungus and insects. Wood, as it is a product of biological origin, is so varied, that the concepts "normal wood" or "subnormal wood" often has a conditional complexion. On sawn-on wood and sawn timber assortment following fungus taints may occur: mould, brownness. Mould funguses generally do not affect physical and mechanical characteristics of the wood.

When wood is affected by biological (fungus), physical (environmental temperature and humidity) and chemical factors – it decomposes.

Wood may last a long time, but volatile humidity and temperature of the environment reduces its lasting, because of that, a variety of cracks, which can damage the woods' integrity ,upspring, that facilitates woods' infection with fungus, and its rapid development. The older the wood is, the better its timbers durability is.

The most effective way to protect the wood from insect and decay is to soak it with special preparations, which are toxic to fungus and insects, - antiseptics.

ATTENTION: These numbers correspond to numbers in the parts list you will receive in your log cabin booklet. Before construction please check the received parts against the parts list as it is more difficult to resolve issues during the construction stage.

All parts of the log cabin are numbered.

Liverpool 4X5 44 mm

Position	Name	B width mm	H Height mm	L Length mm	Q.
003.	Foundation treated bearer	-	-	3813	10
008.	Floor board (Tongue and Groove)	-	-	4707	18 m2
009.	Floor strips	-	-	1884	4
009a	Floor strips	-	-	2384	4
010.	Strip (for inside roof)	-	-	17377	1
017.	various wall log	44	135		
037.	Roof board	-	-	2186	26,5 m2
039.	Fascia board	-	-	2206	4
039a	Fascia board strip	-	-	2216	4
039b	Roof strip	-	-	3000	4
044.	Double outside doors	A 1295X1860(double glazed)			1
045.	Double windows	C 1380X910(double glazed)			2
046.	Double door strip (horizontal)	-	-	1395	4
046a	Double door strip (vertical)	-	-	1830	4
046b	Double window strip (horizontal)	-	-	1480	8
046c	Double window strip (vertical)	-	-	880	8
058.	Rhombus	-	-	135	4
070.	Door furniture	-	-	-	1

Assembly guide Liverpool 4x5

Assembling this Log Cabin “Liverpool 4x5” should take place during dry weather only. If it starts to rain during the assembling process, the wood should be covered over.

After completion, the cabin should be immediately protected with an appropriate paint or wood treatment.

Before erecting this cabin it is important to make a firm base, ideally using concrete or concrete slabs.

It is very important that the base corners must be at right angles it is completely level.

Unless in the wall between windows and doors can be found space, in consequence water can get into the cabin.

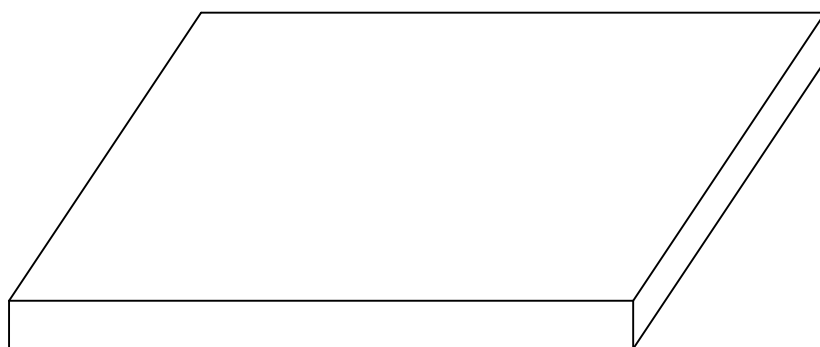

After completing the base the bearers, Pos. 003 are put into position following the Installation Guide diagrams, and then bolted into position.

The space between impregnated floor joists must be kept exactly how is shown at the Foundation plans (according to the picture at page 4)

The first two and the last two foundation treated bearer must be put together. According to the picture.

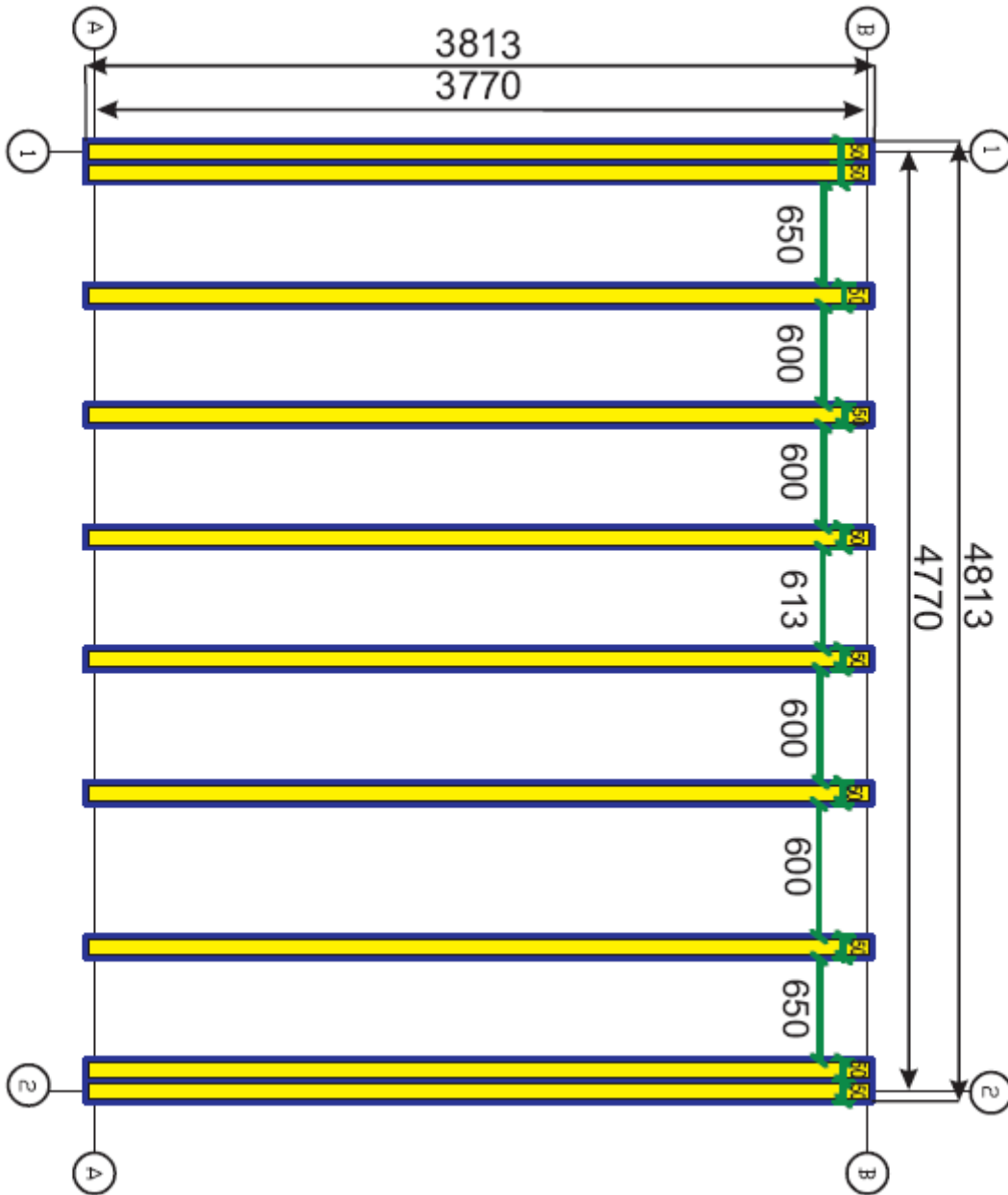

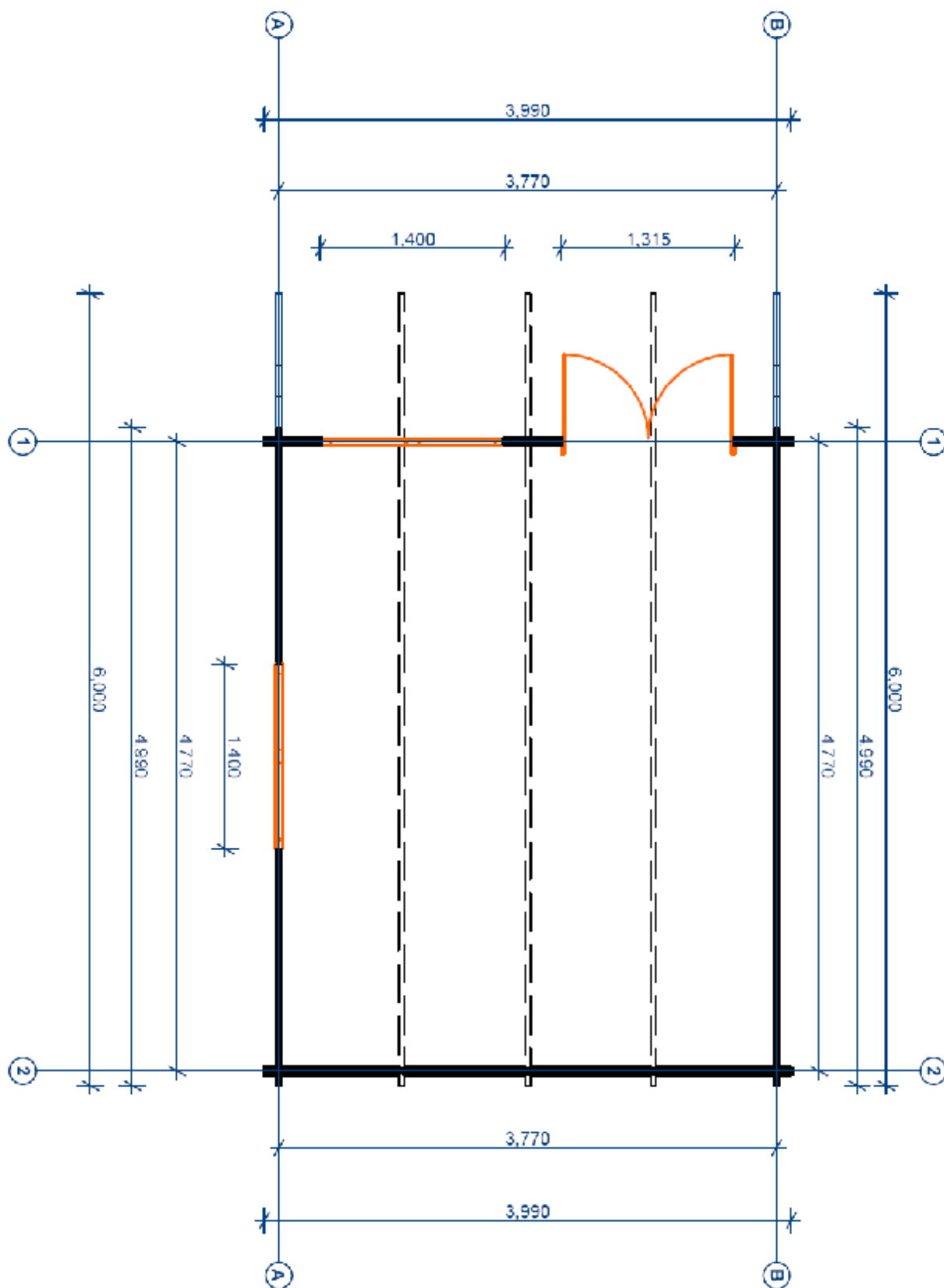

ATTENTION: In the package you will find some boards for hammering wall boards. Don't hammer directly to the wall board just with scutch. Please do it according to the picture.

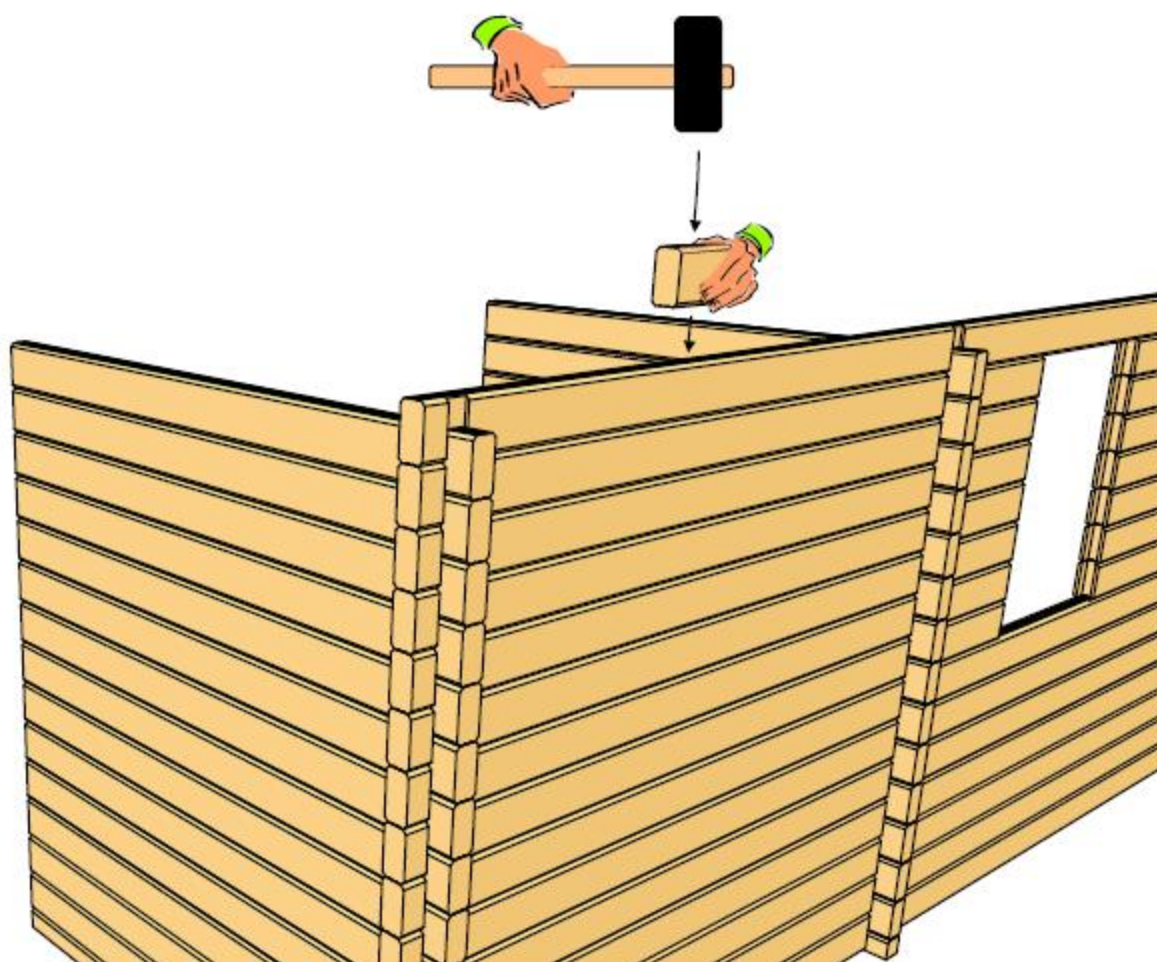

It is advisable to use a spirit level during the construction of the cabin. Using the Installation guide together with the Parts List for reference you can start erecting the walls. Beginning with part No. 1-1-BA and 1-2-BA for the back and front walls and following the installation Guide, fit the boards' one on top of the other. Ensuring the corners lock. Again it is advisable to use a spirit level during this process.

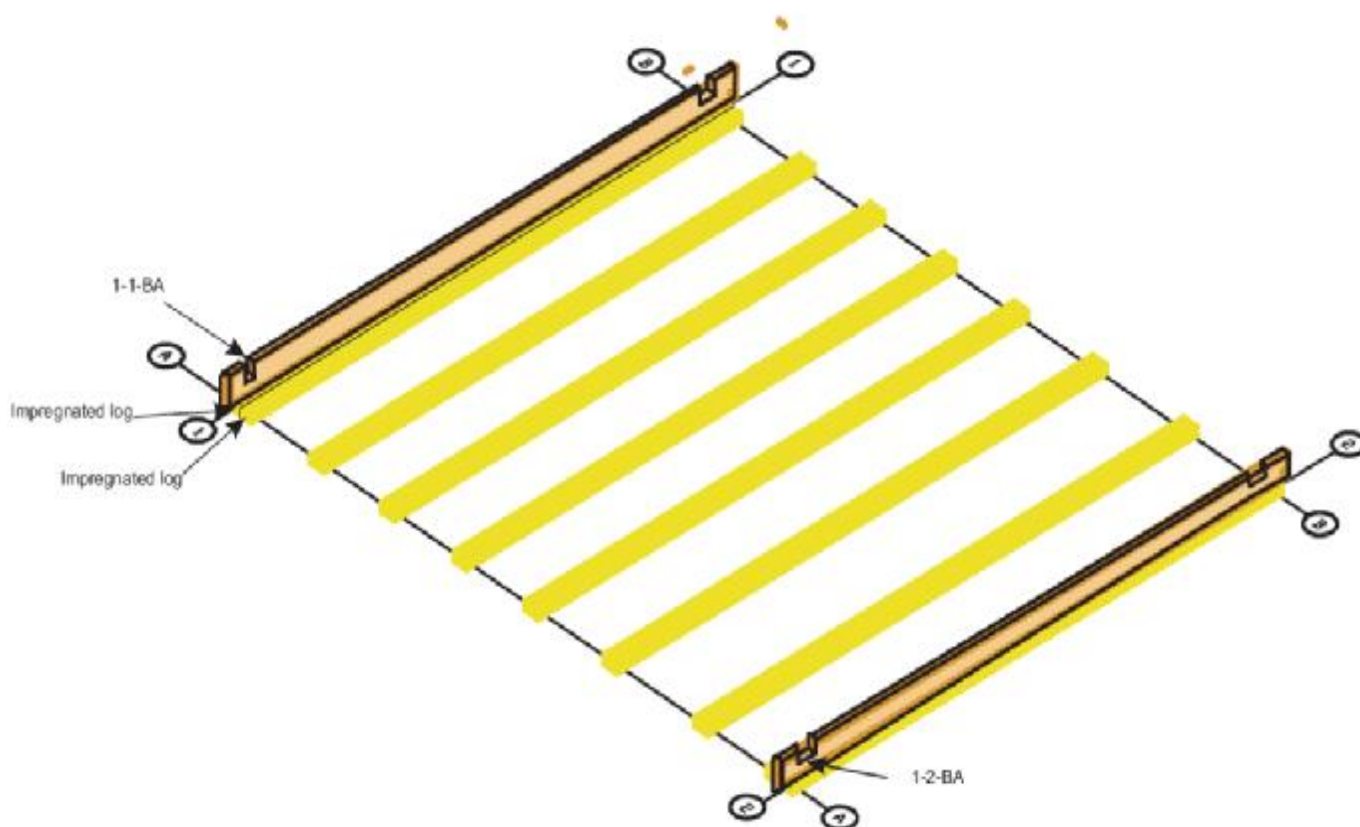

All parts of the log cabin are numbered.

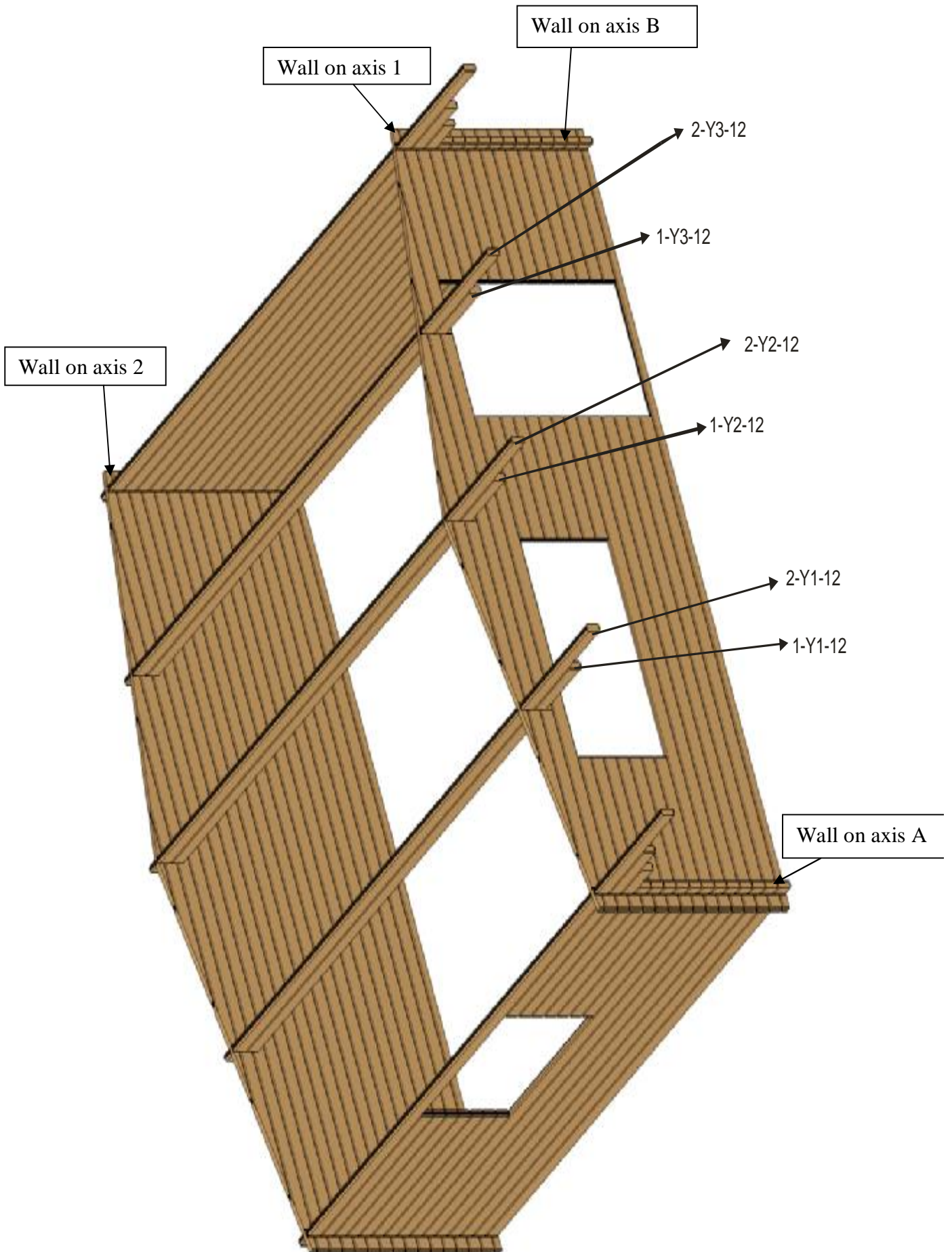

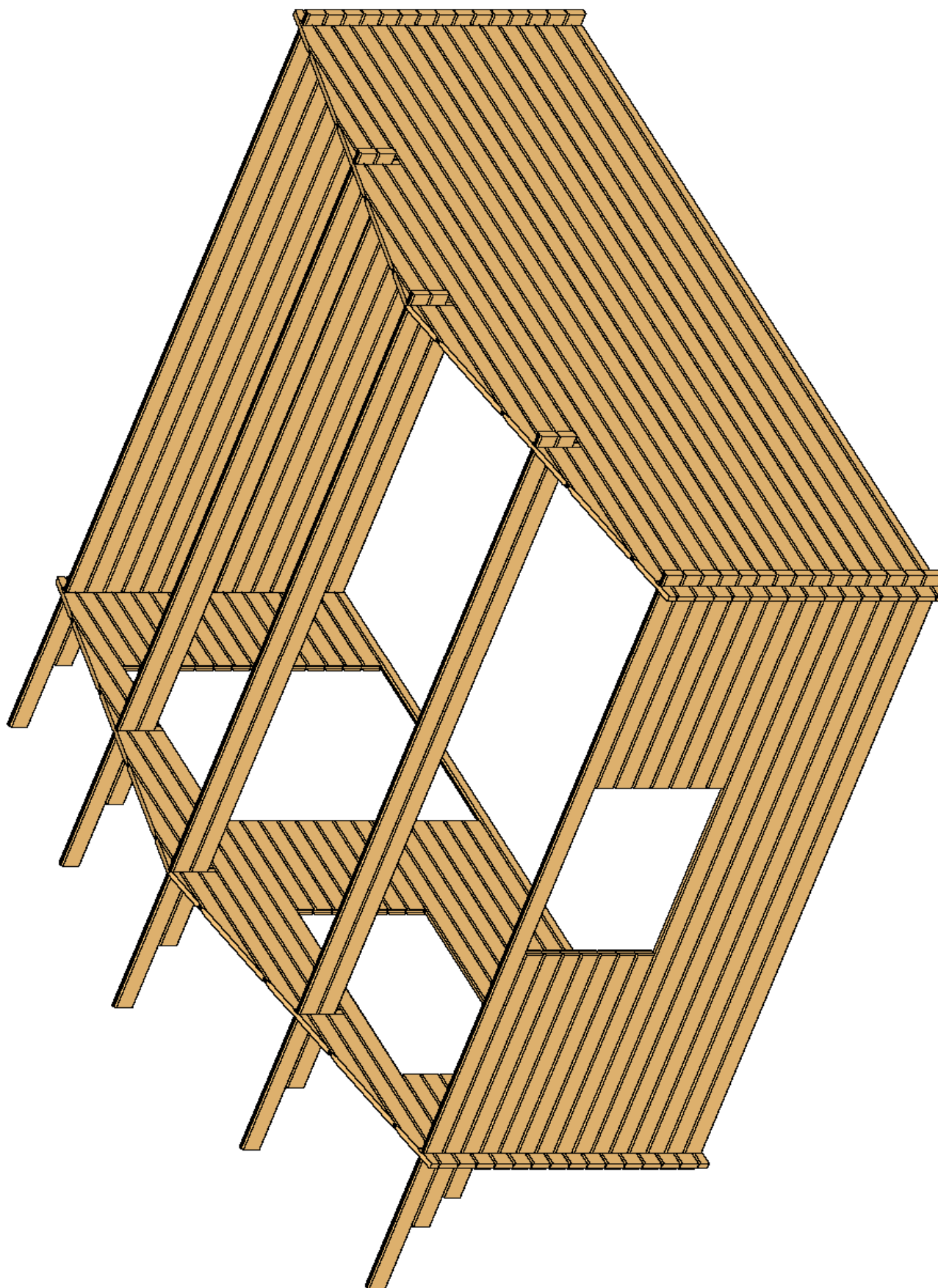

Wall on axis 1

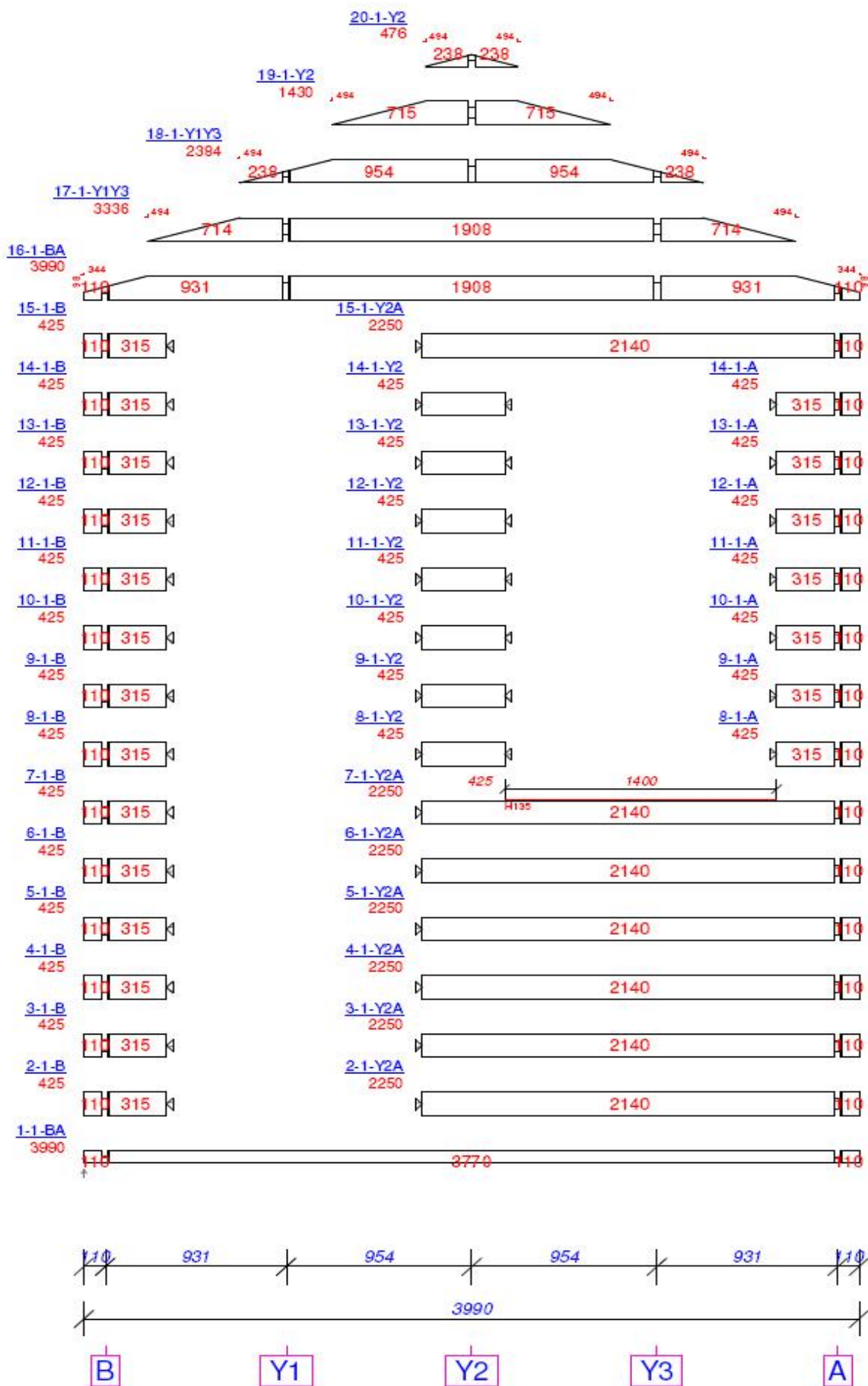

Wall on axis 2

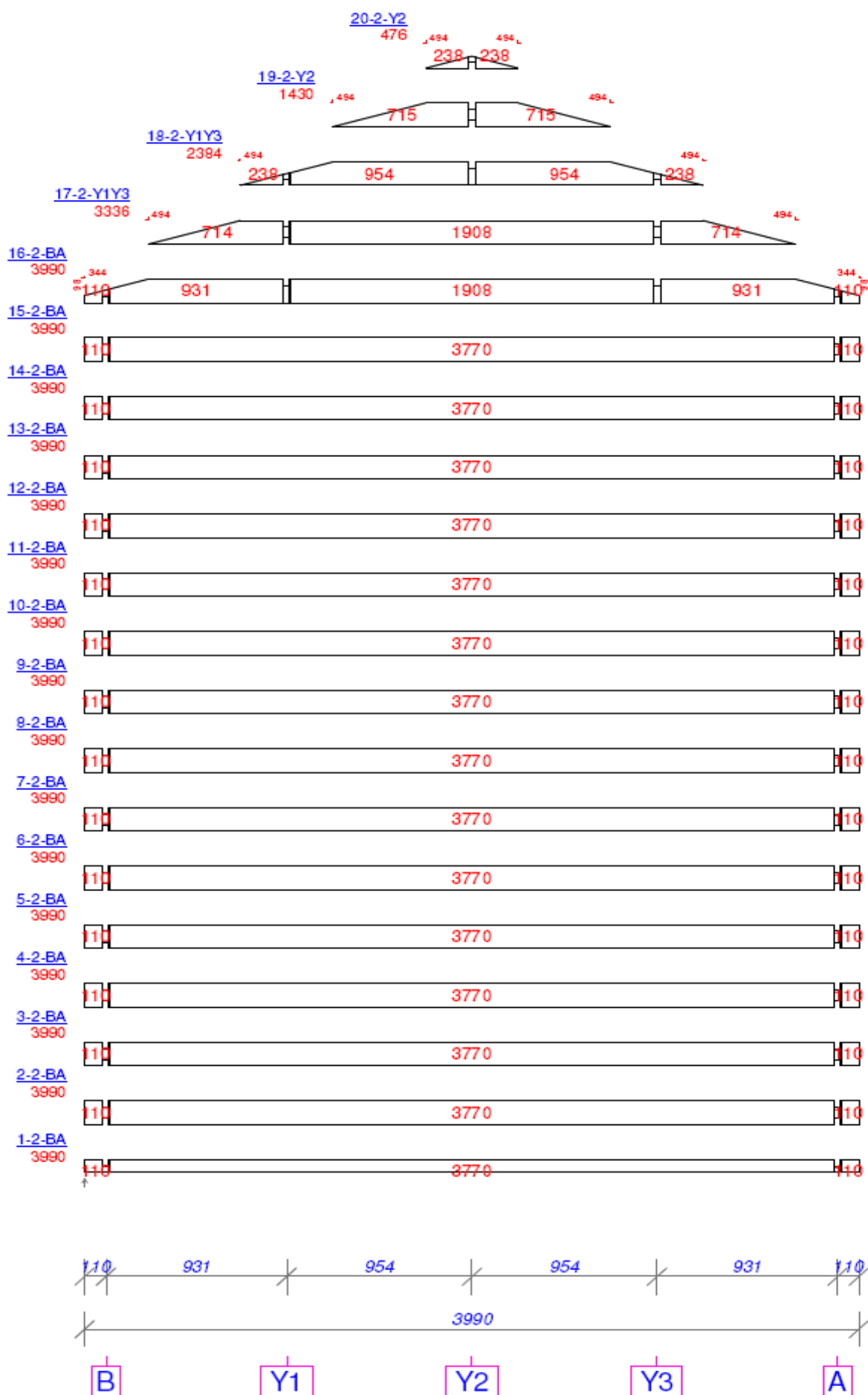

Wall on axis A

15-A-12
6000

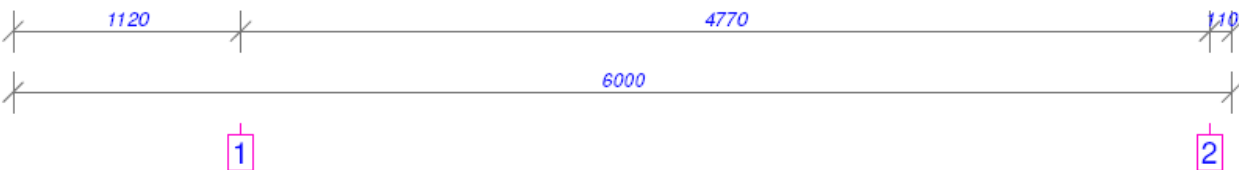
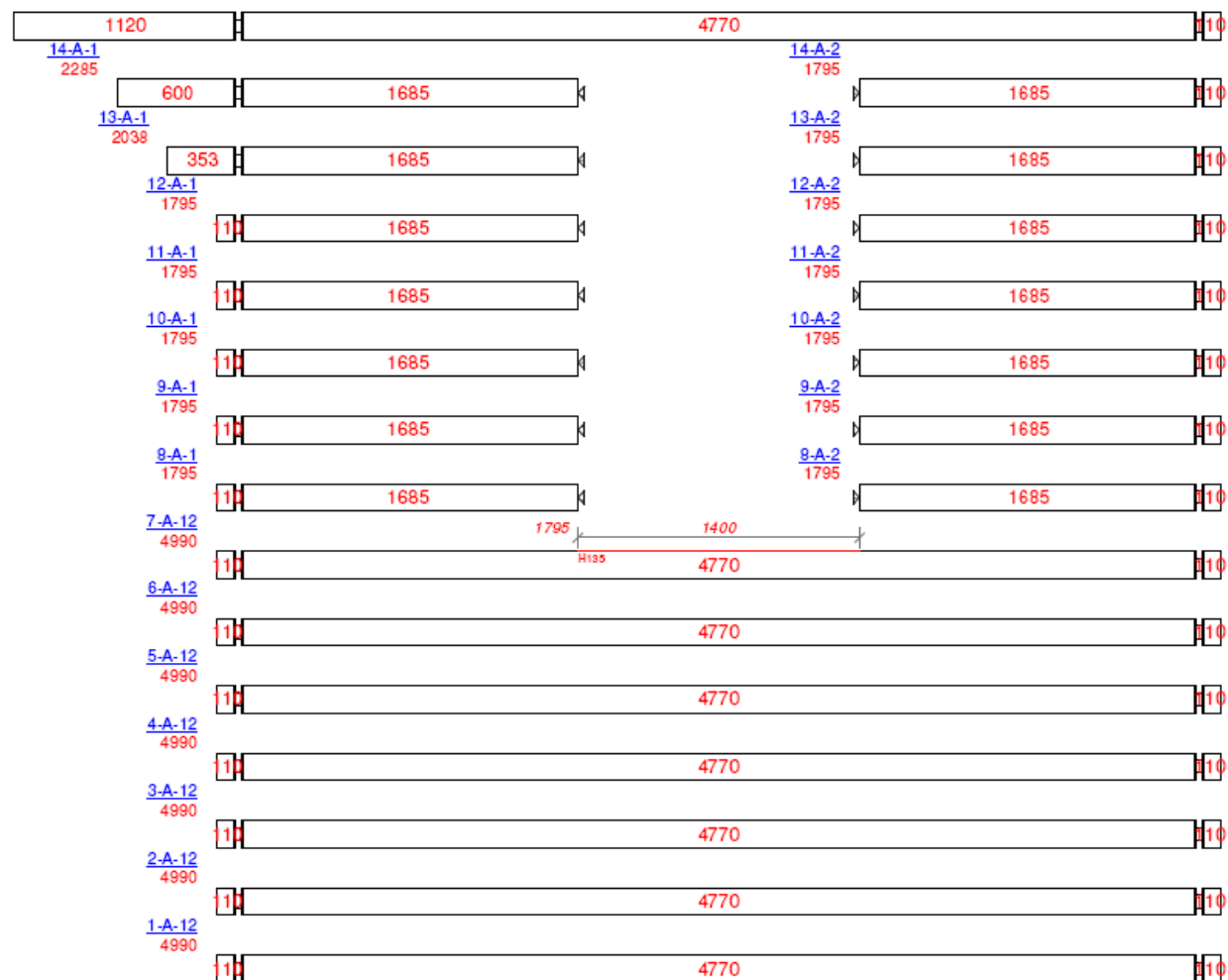

Wall on axis B

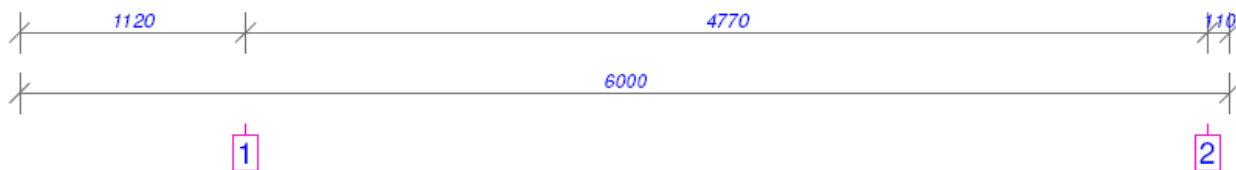
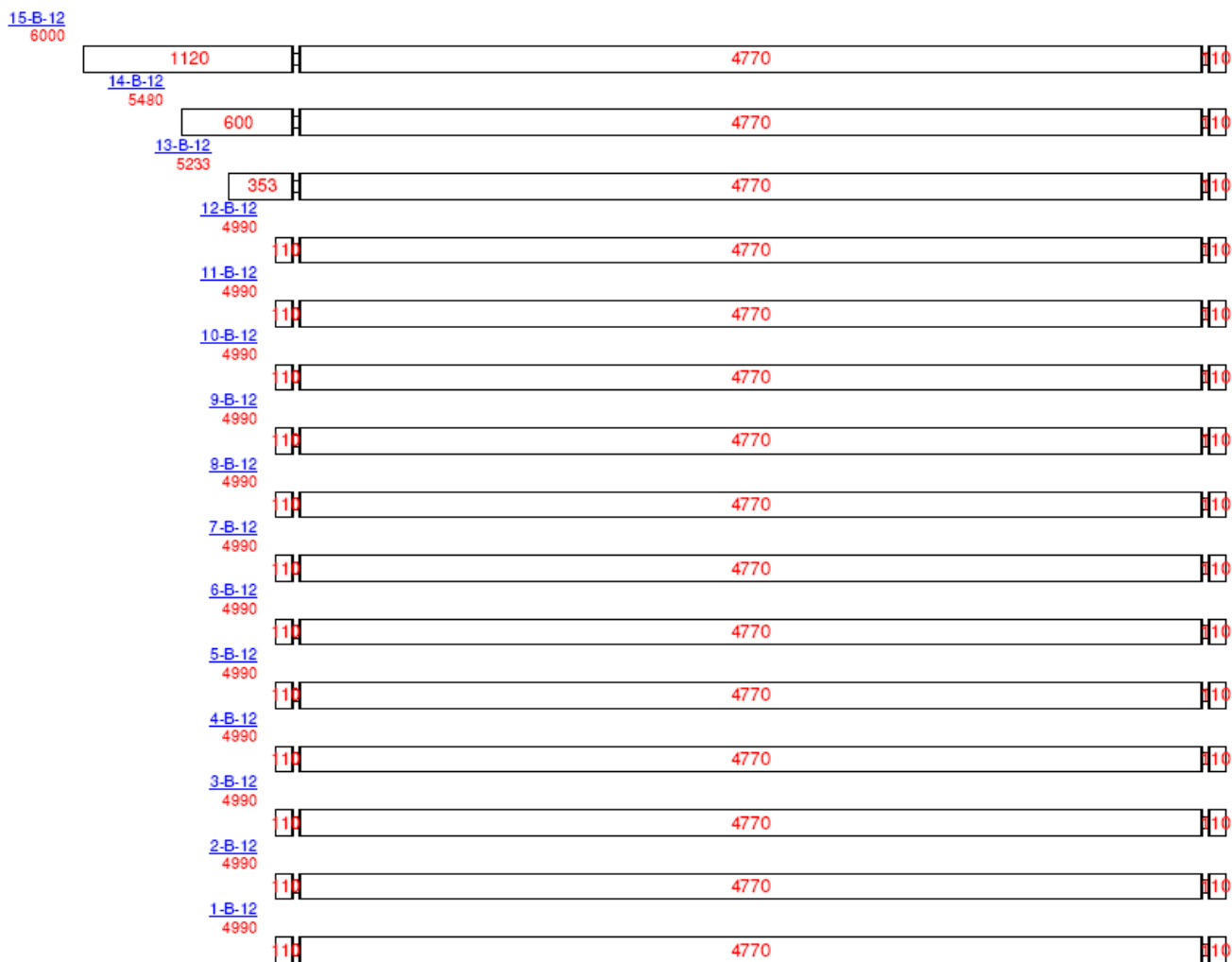

Wall on axis Y1

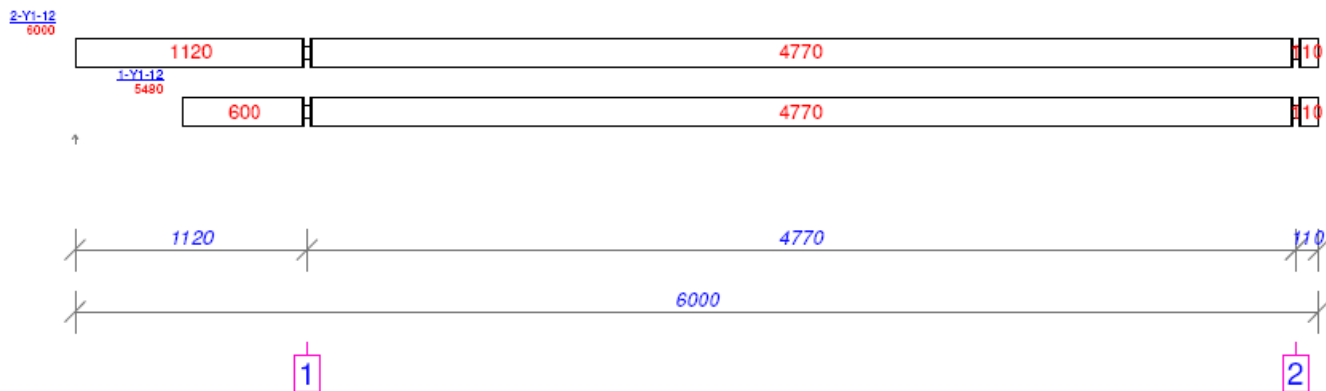

Wall on axis Y2

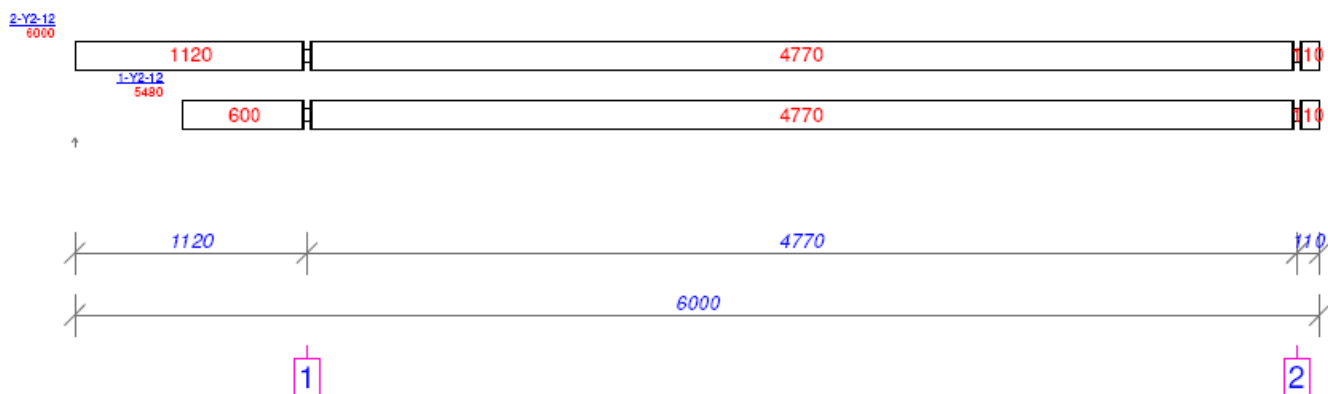

Wall on axis Y3

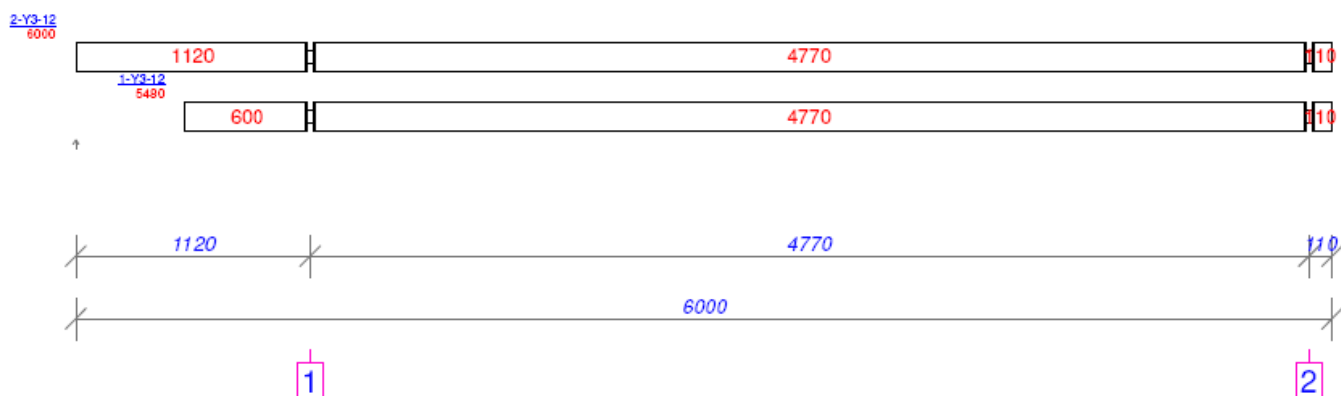

When the external walls reach the height of the gables the doors can be installed.

Now you can position the pre-fabricated gable, part No. from 16-1-BA to 20-1-Y2, from 16-2-BA to 20-2-Y2.

When the gable is in position the roof joists can be put in to place. This is followed by the roof boards' pos. 037 which are screwed or nailed into place. This process should be done working from the front to the back.

For fitting the roof boards we recommend using roof board / mdf screws about 4,5-5 cm in length. Please ensure that 2 screws are used to secure each individual board. Additional screws / roof tacks can be used to secure the middle of the board to the side roof joists for extra security.

As soon as the roof is installed it should be sealed immediately with roofing felt and/or Bitumen tiles – which are supplied as optional extras.

When the tiles/felt is in place the border for the gables and eaves Pos. 039, 039a and 039b can be screwed or nailed into place.

Floorboards pos. 008 is fitted last. These are screwed or nailed onto the bearers' pos. 003.

The roofing and flooring is commercial quality tongue and groove. The smooth planed side of the flooring boards should be placed upper- most.

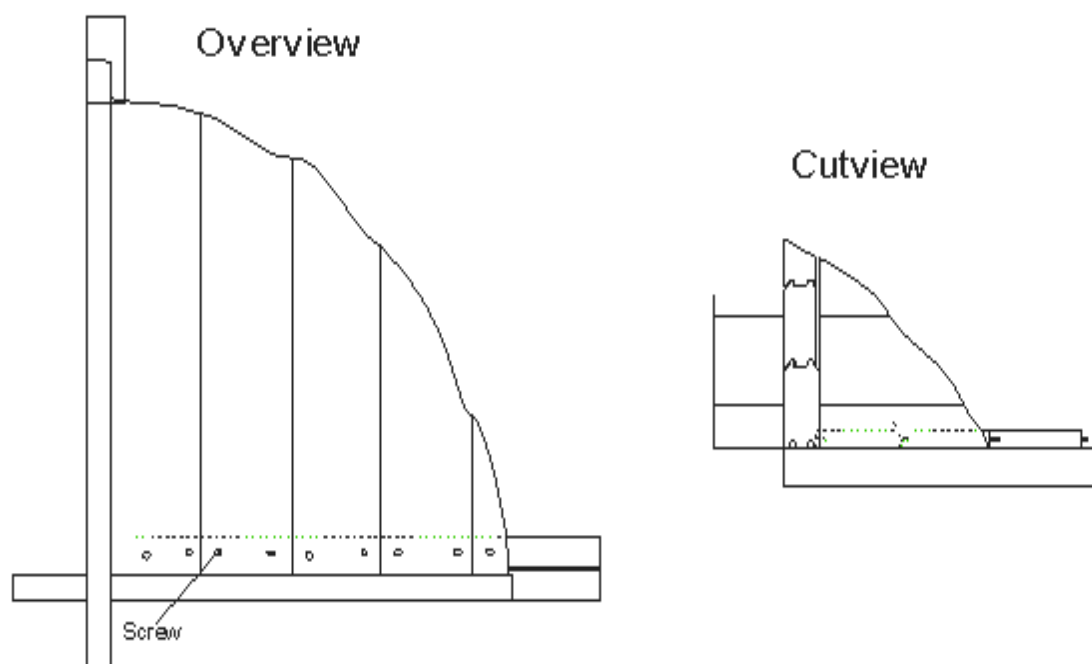

ATTENTION: Before you start the mounting the floor boards, please pay attention to the specification on the page 2.

If pos. 008 at the specification is from two positions (floor boards are butt – jointed) - pos. 008 and pos. 008a, you must put the impregnated floor joist exactly how is shown at the foundation plan. According to this picture.

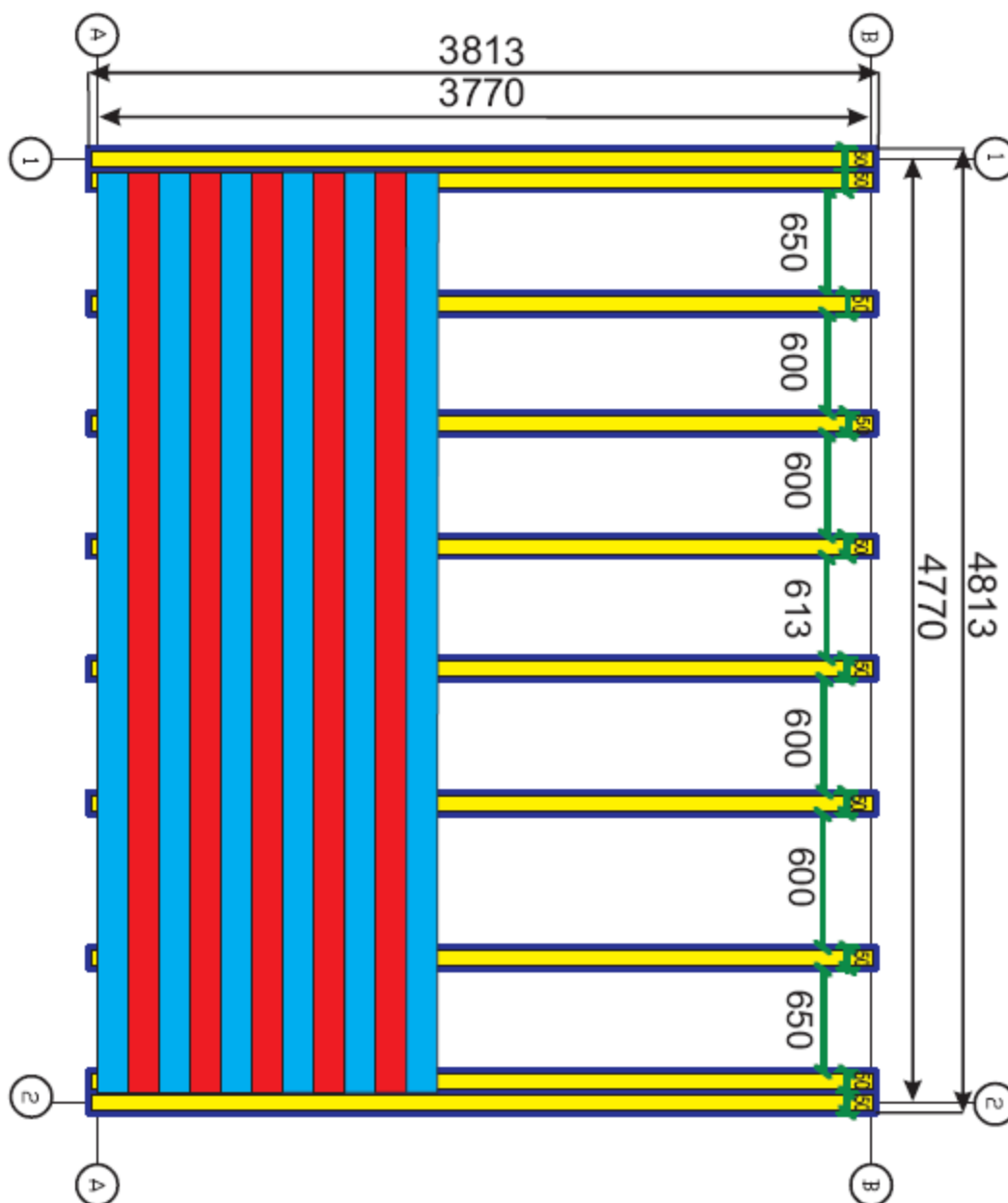

Doors and windows installation

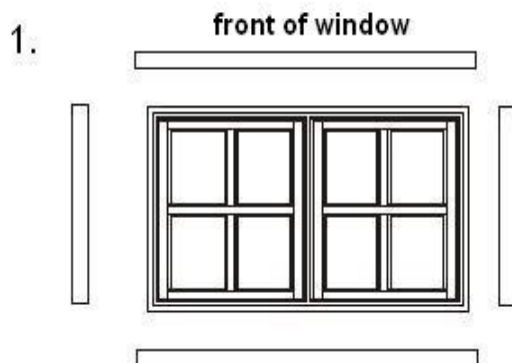

lay window frame on a level surface

lay four pieces of frame around window

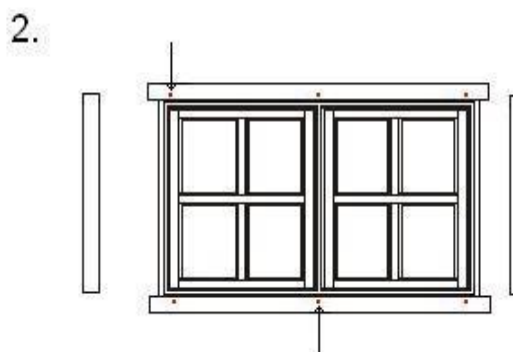

screw top and bottom pieces to window frame as shown

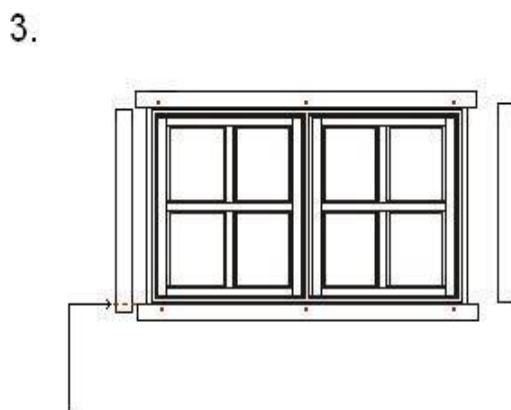

cut side pieces to fit as necessary, then screw to frame as before

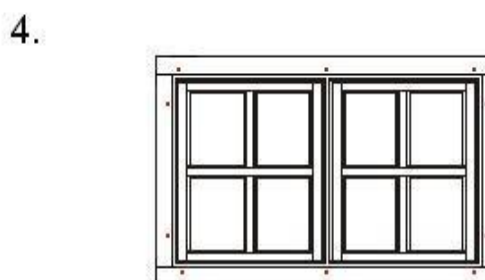

all pieces attached to front of window frame

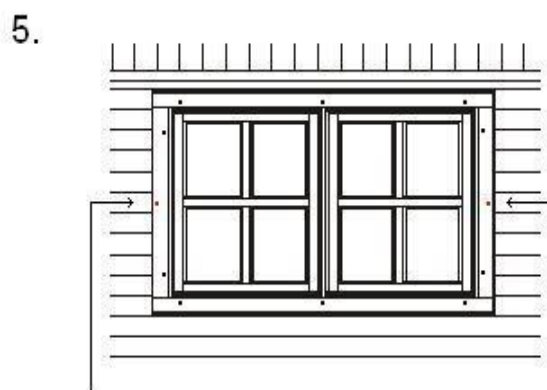

offer up window to cabin and screw in either side to cabin wall to hold in place

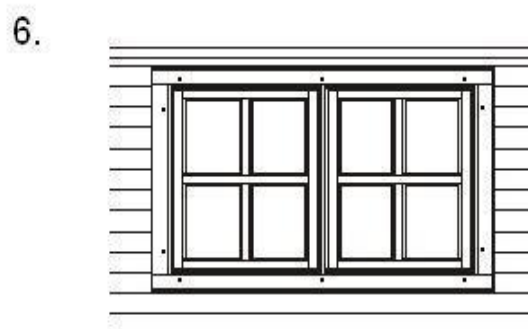

go into cabin and repeat attaching the pieces to the window frames to secure windows

Windows can be opened in one of two ways: firstly wide side to side action with window fully open. Secondly by means of a ventilation catch in order to allow a small amount of airflow into cabin.



Ventilation – please ensure that the window catch lever is in the right hand position.



Slowly release the catch at the top of the window.



The window will then tilt slightly inwards at the top for ventilation.

Please attach the wind boards provided for the door and window surrounds to the window/door frame only. Do not attach direct to the cabin walls in order to allow the cabin wall to settle once built

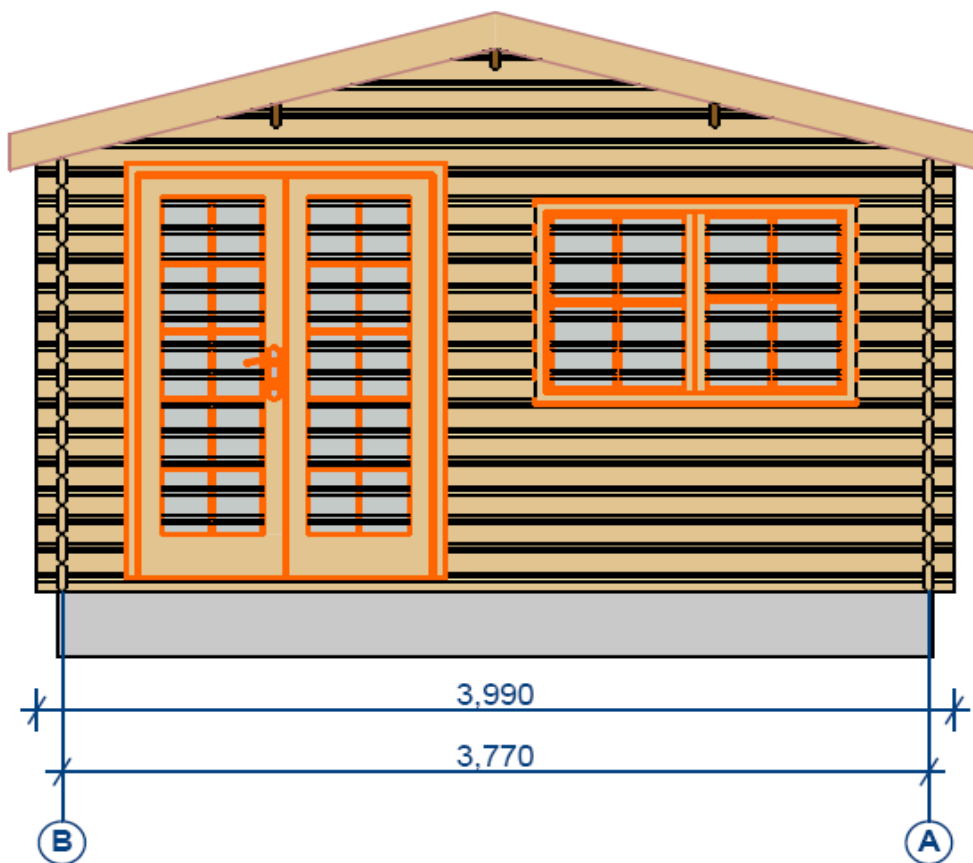

+2.700

+1.996

±0.000

3,990

3,770

B

A

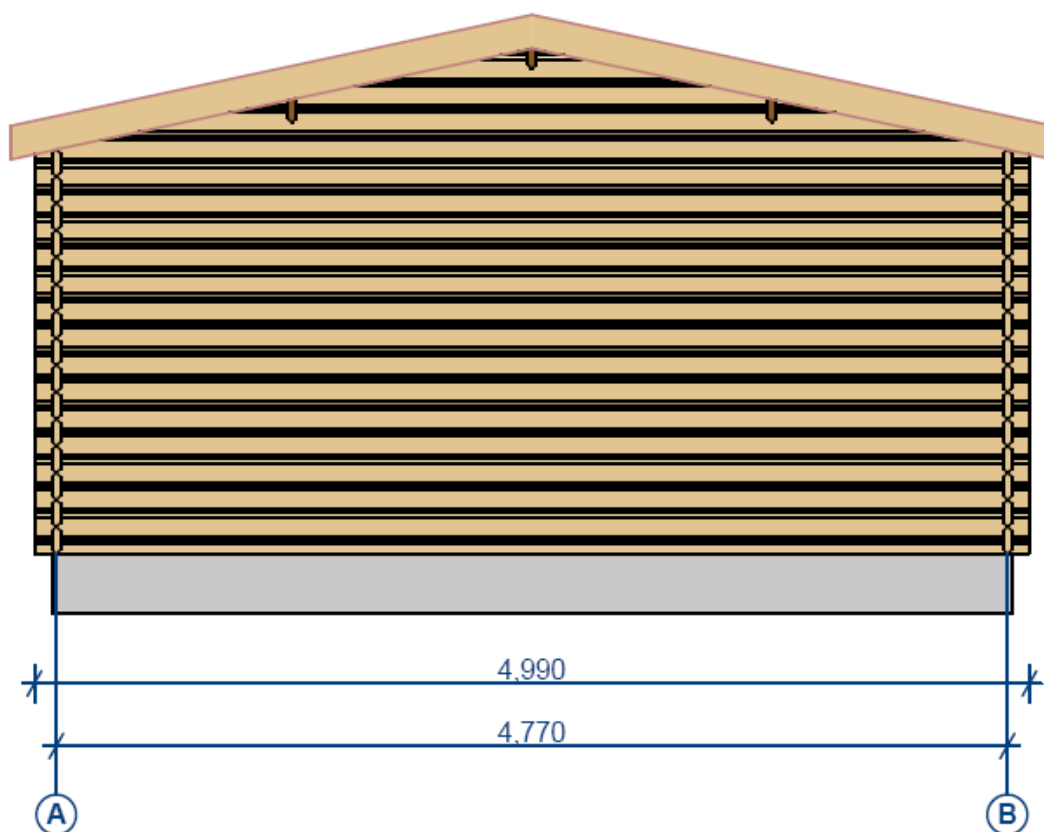

+2.700

+2.001

±0.000

4,990

4,770

A

B

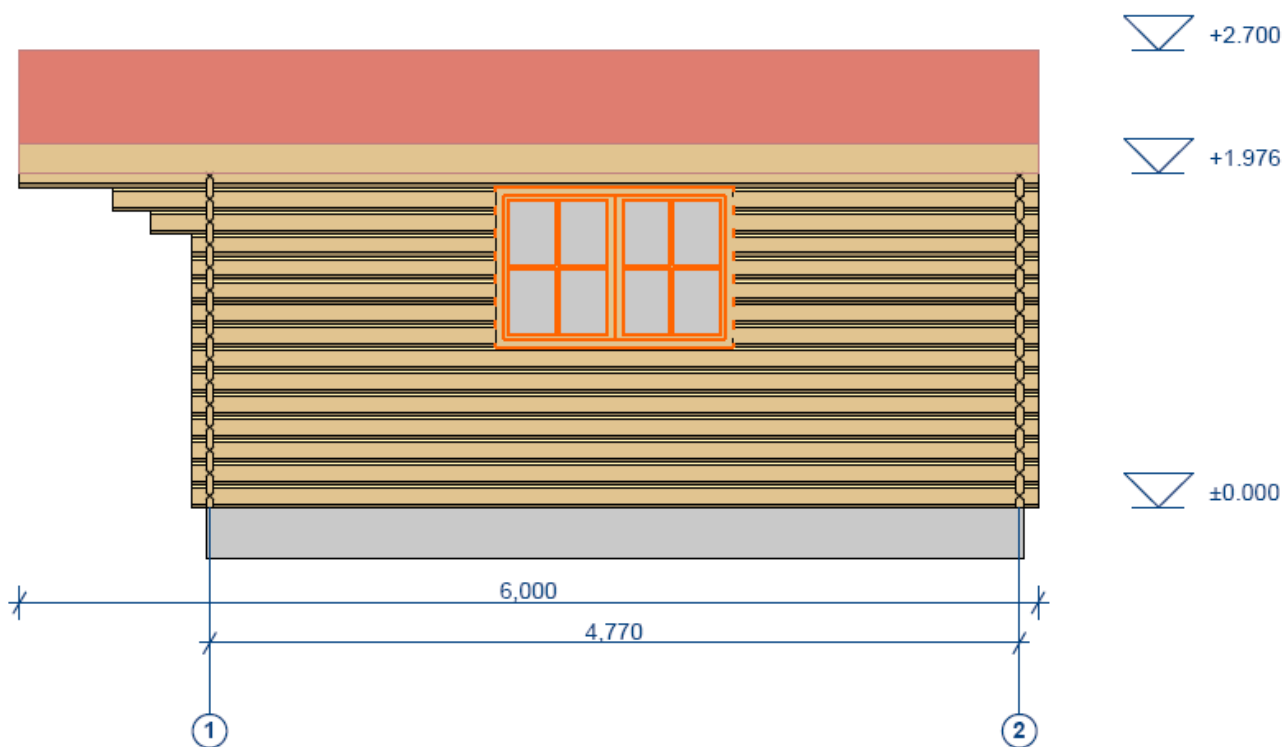
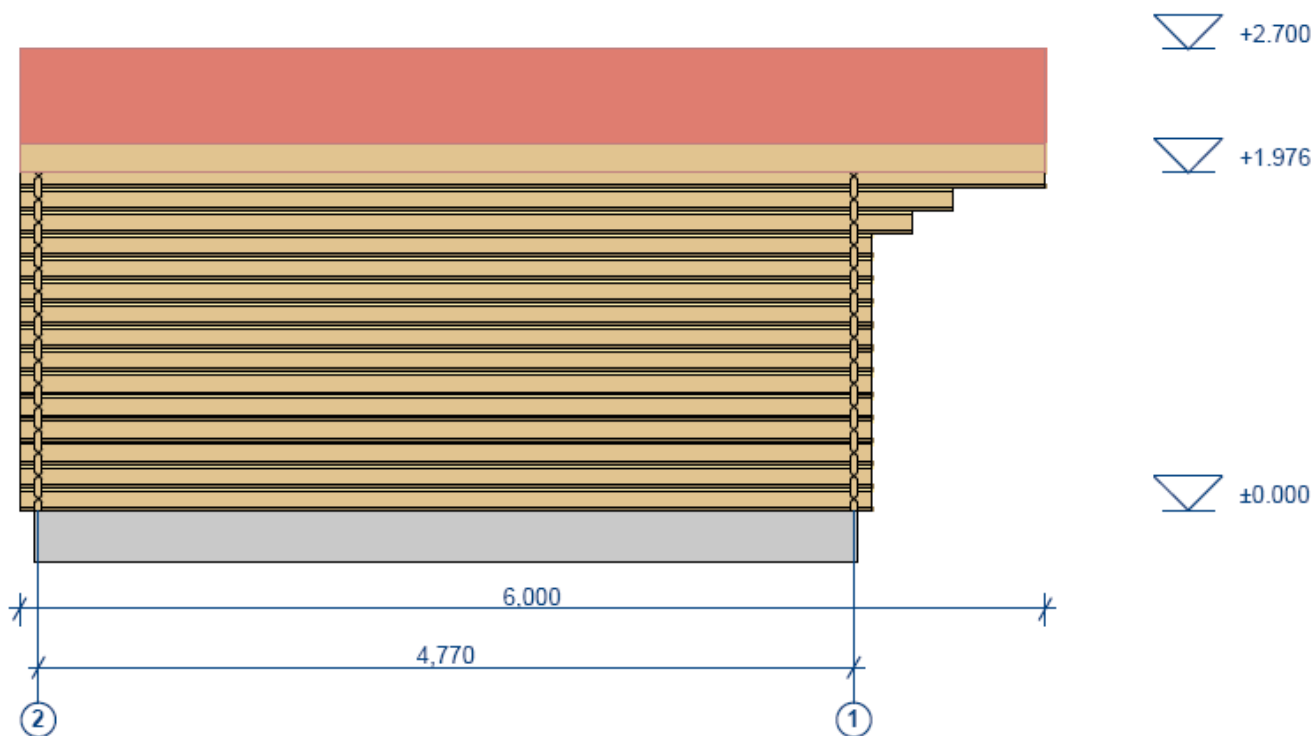

Please note:

Wood is a natural material, which comes with differing textures and colour nuances. These form part of the appeal and natural attraction to this product but also mean aesthetic variations.

Complaints:

If a cause for complaint should arise please follow this procedure:

Inform your retailer and return your control list, describing the problem and making note of any parts nos. that may be damaged. As soon as we receive notification of a complaint we shall do our best to resolve the matter as quickly as possible.

Guarantees are limited to the replacement of incorrect materials.

We trust you enjoy your Log Cabin.

LOG CABIN SHINGLE TILE INSTRUCTION

ATTENTION:

We are not responsible for water leakages due to incorrect tile installation or improper preparation of the roof deck. Please therefore read these instructions carefully. If you have any installation questions please ask us before starting.

Sometimes a small deviation in colour of the tiles occurs between tiles in the same or different packs. This is not a defect of the material and is actually designed to increase the decorative beauty of the completed roof. In order to reduce colour difference during installation of the tiles, it is recommended to mix tiles from packs at random in order to create a mixed colour effect.

Storage:

Full pallets of tiles cannot be stored one on top of the other, otherwise this can compress the tiles into sticking to one another before use. In order to avoid shingles sticking to each other in a pack they should be protected from direct sunlight and any direct heat source. Each pack should be bent and shaken before opening, this helps to separate the shingles from each other.

It is not recommended to walk on the roof in hot/sunny weather because the cover might be damaged. Special ladders should be used for this purpose.

Usage of materials for roofing cover:

Each pack of bourne or hexham tiles contains 3 m² of tile coverage (including overlapping). Each pack of ridge tiles contains 5m² of tile coverage (including overlapping).

When calculating the amount of materials needed for roofing cover it is necessary to evaluate the quantity of tiles required depending on the complexity, degree of slope and size of the roof. Please remember to calculate extra tiles required for wastage (between 5 – 15% extra) as it is always better to have too many than too few tiles. Extra spare tiles, if stored correctly, can be used to repair any areas of damage in the future.

Installation of bitumen shingles: Initial row (tiles of ridges/cornice):

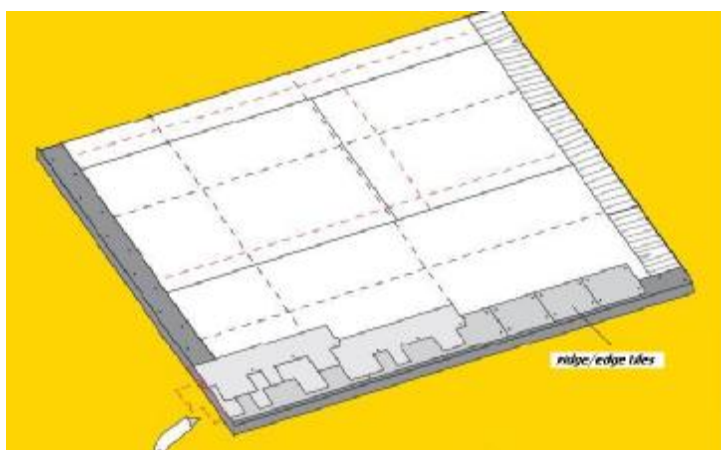

Ridge/cornice tiles or the usual tiles (with the jagged edge cut off) are used for the initial row of tiles along both the eaves of the roof as well as the pitched cornice at the top.

The silicon film should be removed from the under side of the tile prior to installation.

Every tile should be nailed to the roof boards with wide headed galvanized roof tack nails. The number of nails depends on the pitch or slope of your roof. It is very important not to over hit the nails. They should be nailed in such a way that the head of the nail head is flush with the tile and not below the surface. The head of the nail should not puncture the surface of the shingle tile.

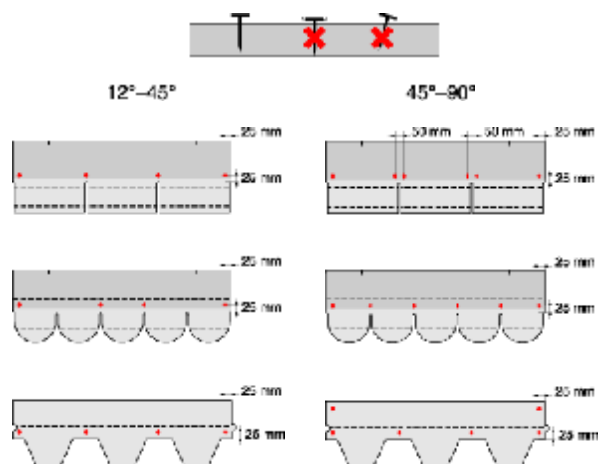

The nails are put 2 – 3 cm from the edge of the tile. Picture on the left indicate the number of nails needed and where they should be applied at certain roof angle. The picture shows the topside of the tile, and the dotted line indicates the place of the adhesive bottom layer.

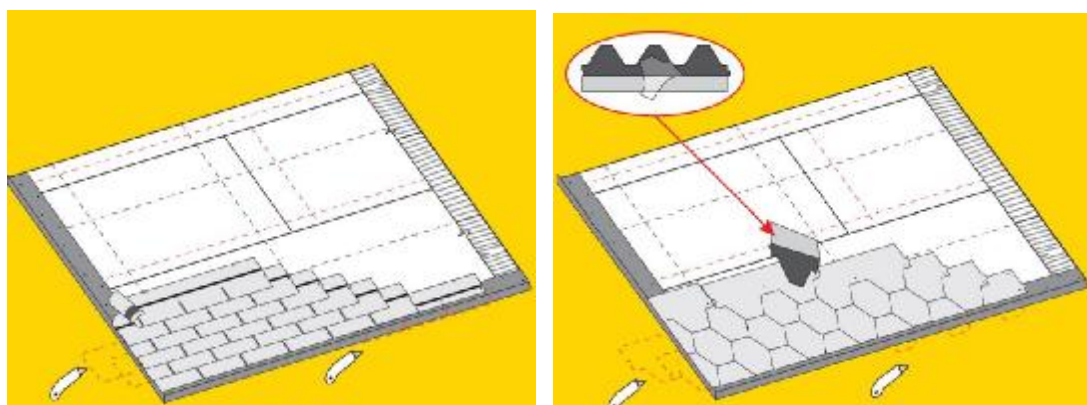

Ridge/cornice tiles should be cut into three parts at the places of perforation and laid in a straight line with an overlap of 3 – 5 cm. They are fixed with two nails on each side of the slope.

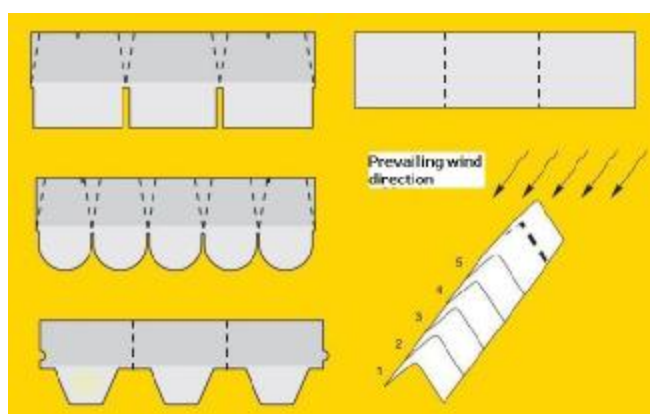

Installation should be performed against the prevailing direction of the wind.



ATTENTION: if ridge – cornice tiles are installed at the outside temperature lower than 10°C it is recommended to bend them on a heated 10 cm diameter tube in order to avoid cracks. (See the picture on the left)

Ventilation:

The durability of the roof construction is longer if the roof has proper ventilation, especially over the usable attic.

Tile Patterns:

Please make sure that the individual tiles are NOT overlapped to cover the darker colour section. Please refer to the pictures for the correct spacing of tiles. If you assemble the tiles with a larger overlap than recommended you will not have enough tiles to complete your roof. We provide the correct quantity of tiles in order to cover your roof according to correct assembly.

We strongly recommend to use wide headed (up with 15-19 mm long) nails to fix the bitumen tiles.

If you are going to put the tiles at lower than +15 degrees outside temperature, please preheat black sealing belt zones or use extra mastics to ensure waterproofing. In this case also recommend to keep tiles in warm temperature (inside) for 24 hours before installation.

The cost of extra tiles and delivery will be paid for by the customer.

HEXHAM TILES PATTERN

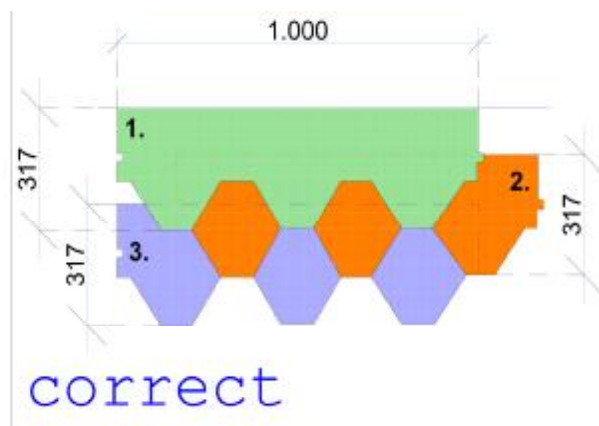
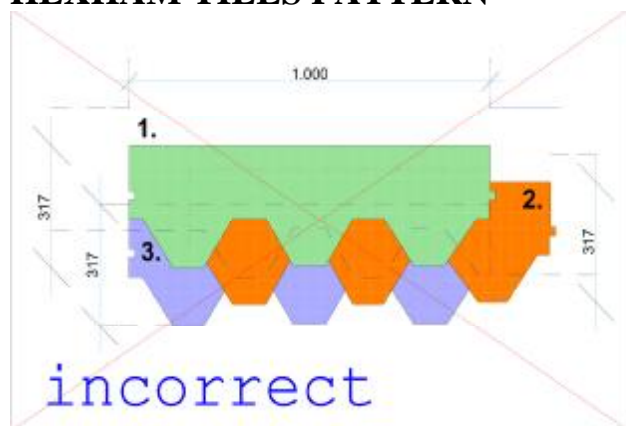

BOURNE TILE PATTERN

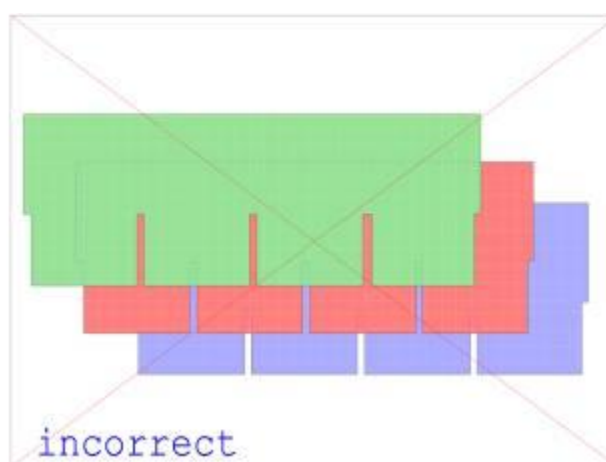
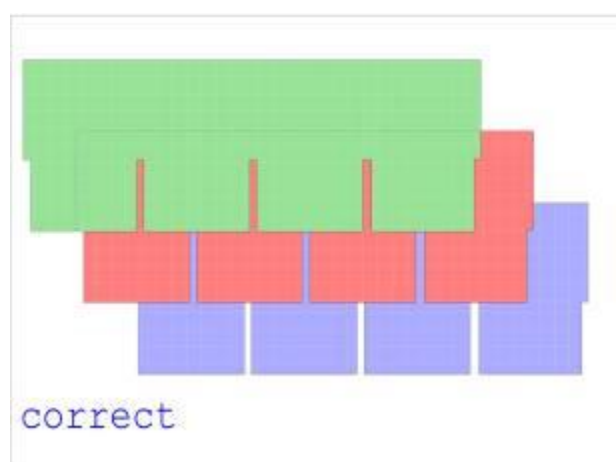

If you have any questions about the installation process of your tiles please call to ask before starting.

ATTENTION:

We are not responsible for water leakages due to incorrect tile installation or improper preparation of the roof deck. Please therefore read these instructions carefully. If you have any installation questions please ask us before starting.

Attention: If in the list of details you found 4 peaces rhombes, two must be set at the front and at the back of house and the last two on the roof strips joint. If you found just two rhombes in the list of details such being the case you must put them at the front and the back of the house (according to the picture).

